

M9526 SERIES

28V SWITCH MODULE

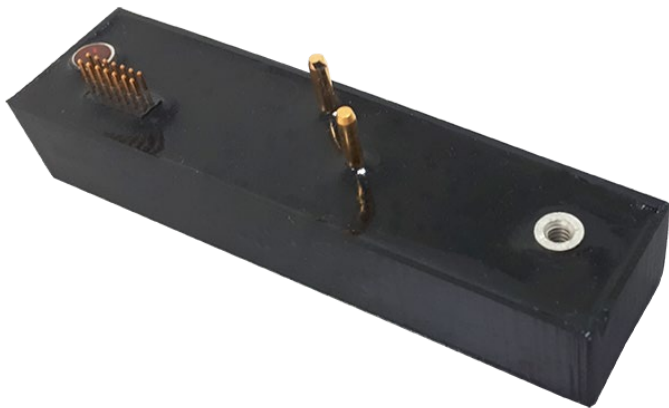

PRODUCT HIGHLIGHTS

- **Short Circuit Current Limit Adjustable**
- **Overload Breaking Current Adjustable**
- **I2C Communication**
- **Discrete Operation Option**

Electrical Specifications

DC Input

Input: 0 to 50 V_{DC}

V_{CC}: 3 to 5.5 V_{DC}

V_{CC} Supply Current: 25mA Typical

Control

- I2C Communication see
- Open drain fault discrete signal
- On/Off discrete signal

DC Output

• Input-to-Output impedance: Less than 2.5 mΩ @ 25 °C

• Max load capacitance per channel: 3 mF

EMC

Complies with MIL-STD-461F (50μH LISN): RE102, CE102, CS101¹, CE101¹, CS114¹, CS115¹, CS116¹, RS103¹

Output

• Overload Breaking Current Adjustable from 2A to 30 A according to I2T curve.

• Short Circuit Current Limit Adjustable from 10 A to 125 A according to SCL curve.

Note 1: Tested with full system

Environmental ¹

Design to Meet MIL-STD-810G

Temperature

Operating: -55°C to +125°C at ambient

Storage: -55°C to +125°C

Altitude

Method 500.5, Procedure I & II

Storage/Air Transport: 40 kft

Operation/Air carriage: 70 kft

Salt Fog:

Method 509.5

Fungus

Does not support fungus growth, in accordance with the guidelines of MIL-STD-454, Requirement 4.

Humidity

Method 507.5, Up to 95% RH

Shock¹

Method 516.6

40g, 11msec saw-tooth (all directions)

Vibration¹

Figure 514.6E-1. General minimum integrity exposure. (1 hour per axis.)

Note 1: Tested with full system

Reliability

2,529,861 hours, calculated IAW MIL-HDBK-217F Notice 2 at +85°C, Ground fixed conditions.

Functions and Signals

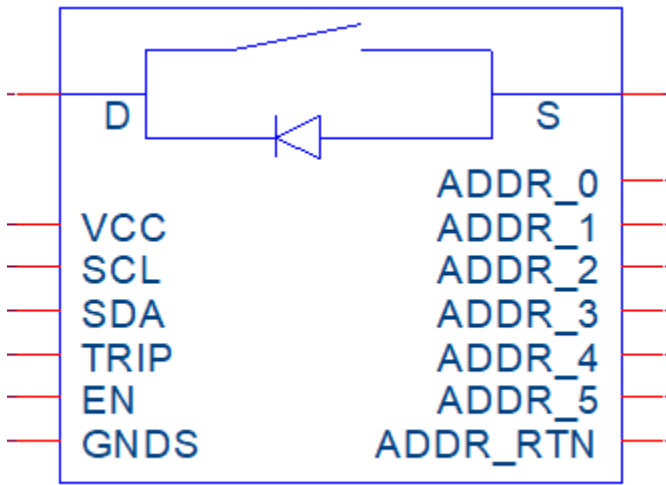

M9526-1

Signal No.	Signal Name	Description
1	VCC	Control supply voltage with respect to GNDS.
2	SDA	I2C bus Data.
3	SCL	I2C bus Clock.
4	TRIP	Open drain fault discrete signal. See Figure 1.
5	EN	The Enable signal is used to turn the SWITCH BRICK ON and OFF.
6	ADDR_0	Used for Slave Device Addressing.
7	ADDR_1	Used for Slave Device Addressing.
8	ADDR_2	Used for Slave Device Addressing.
9	ADDR_3	Used for Slave Device Addressing.
10	ADDR_4	Used for Slave Device Addressing.

11	ADDR_5	Used for Slave Device Addressing.
12	ADD_RTN	Used for Slave Device Addressing.
14	GNDS	ground for I2C, TRIP, EN and VCC.
15	D	Drain for Power Path. For positive voltage switch it will be the input voltage side connection.
16	S	Source for Power Path. For positive voltage switch it will be the load side connection.

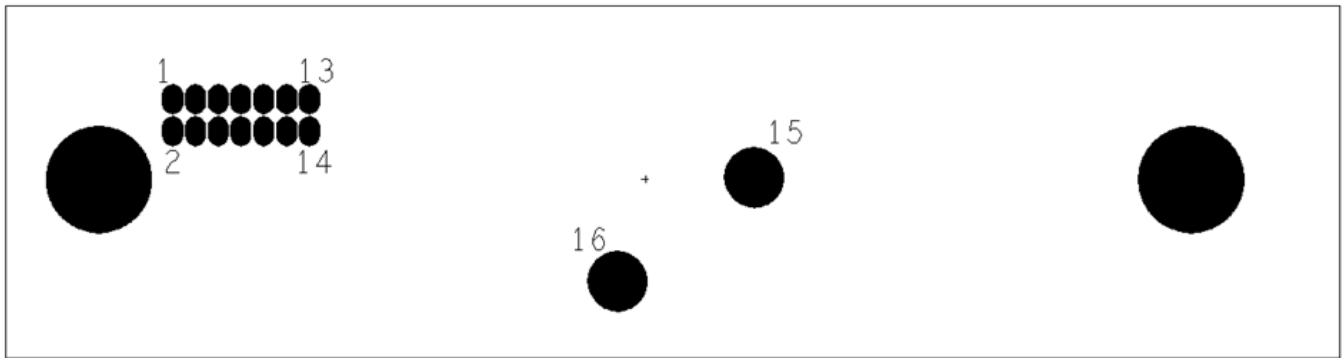
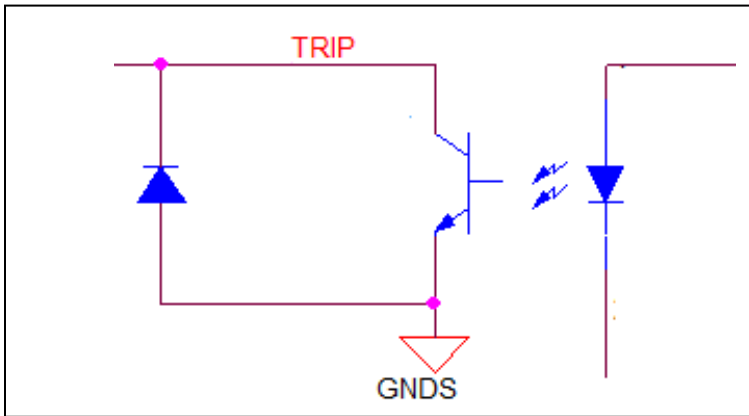

Figure 1 – Trip stage



1. Typical Tests Results

2. Typical Characteristics

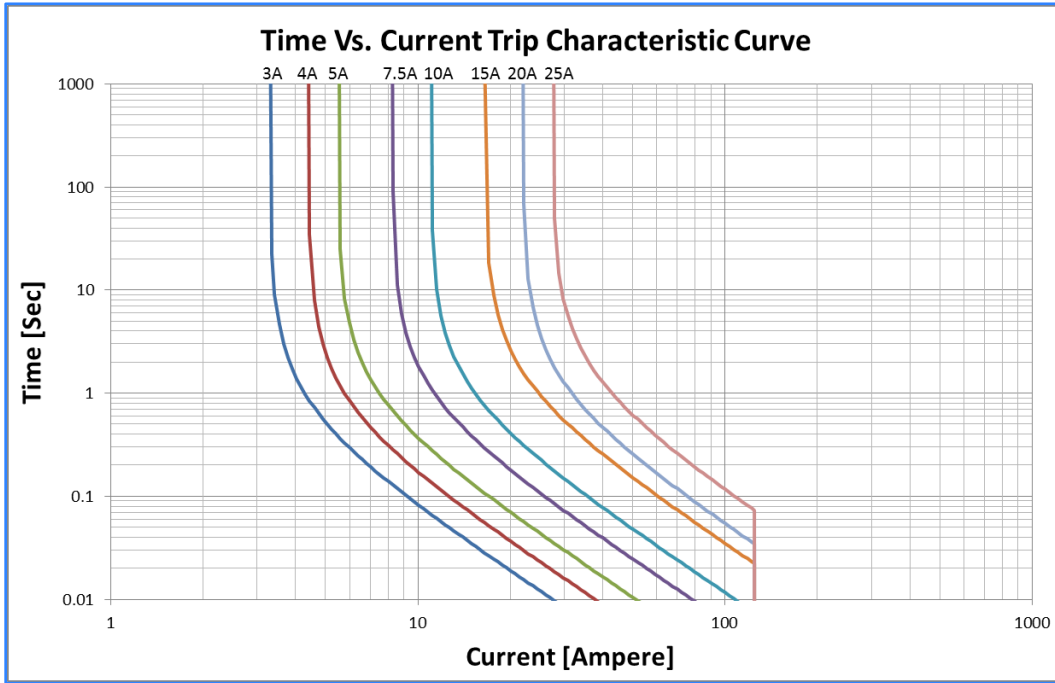

Figure 2 - Time vs. Current Trip

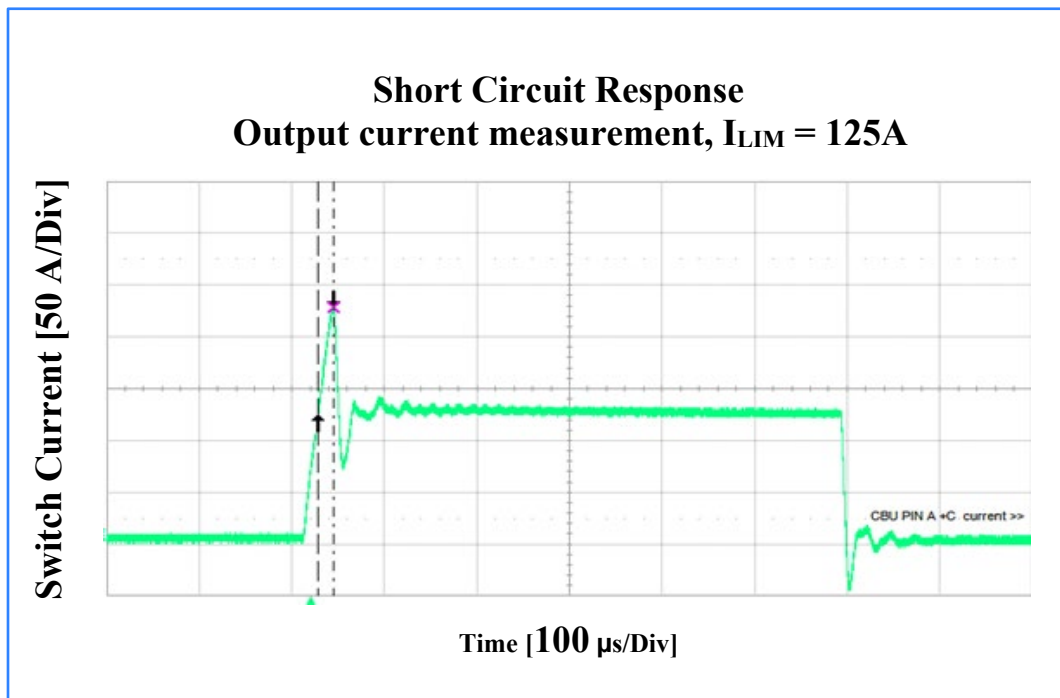

Figure 3 - Short Circuit Response

3. I2C Protocol

Slave Address:

For $0 \leq ADDR \leq 7 \rightarrow ADDR + 0x70$

For other Address = ADDR

Slave will be read as a memory device with one byte of internal address.

Byte order shall be little endian. For example, 01h address will be the LSB of VOUT1.

Internal Address	Name	Function	R/W	Number of bytes	notes
00h	STAT	Status Register	R	1	STAT[0] = Reset Flag (RST) STAT[1] = Switch State ('1' = ON) STAT[2] = Trip Status ('1' = Fault) STAT[3] = Short Status ('1' = Trip from short circuit) STAT[4:7] = Reserved
01h	OUTCURR	Load Current Measurement	R	2	LSB = 62.5mA
03h	VOLTD	Voltage Drop Measurement	R	2	LSB = 62.5mV
05h	TEMP	Temperature Measurement	R	2	LSB = 0.0625°C
07h	I2TACC	I ² t Status	R	3	I ² t accumulator with respect to I2T_LIM
0ah	CTRL	Control Register	RW	1	CTRL[0] = Switch Enable ('1' = En) CTRL[1] = Trip Reset ('1' = Reset) CTRL[2] = Reset Flag (RST , Reset value = '1') CTRL[4:7] = Battle Mode (0xD = Battle Enable)
0bh	OLCL	Overload Current Limit	RW	2	LSB = 62.5mA
0dh	I2T_LIM	Maximal I ² t Setting	WR	3	Thermal Constant(TC) is the trip time for twice of the overload current setting. I2TACC can be set by following formula: $I2TACC = (I_{OVERLOAD} * 16)^2 * TC * 16$ TC [s], I _{OVERLOAD} [A]
10h	SCCL	Short Circuit Current Limit	RW	2	LSB = 62.5mA

Timing Diagram

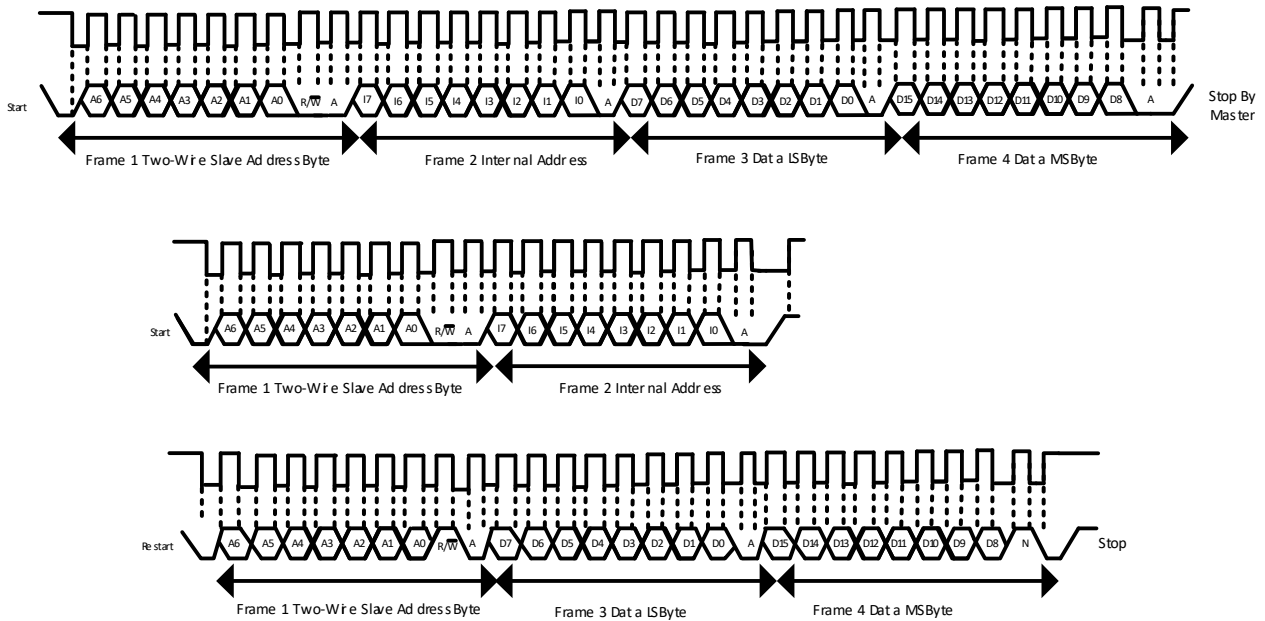

A[0:6] – Address
 D[0:15] – Data
 I[0:7] – Internal Address
 A – ACK
 N – NACK

Outline Drawing

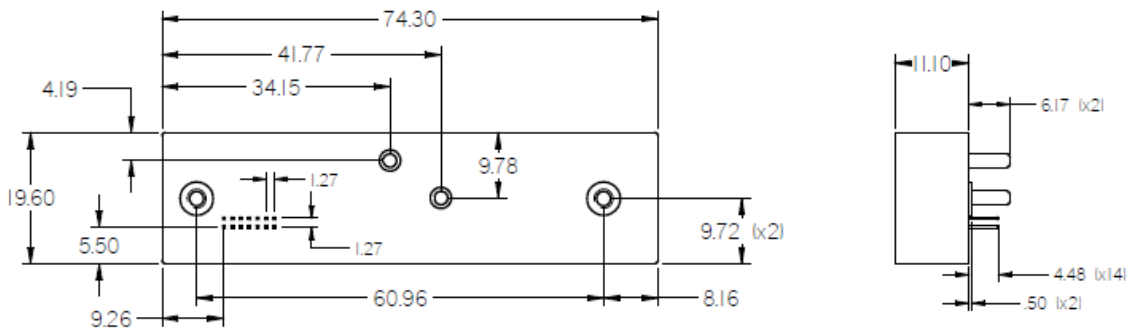

Notes

1. Dimensions are in mm
2. Weight: 32g
3. 3D model available

Standard Configurations

Part Number	Input		Output	
	Input Voltage range	V _{CC}	Voltage	Current
M9526-100	0 to 50 V _{DC}	3 to 5.5 V _{DC}	Following Input	Adjustable

Note: Specifications are subject to change without prior notice by the manufacturer.