

## M8737 SERIES

*DC/DC POWER SUPPLY*



### PRODUCT HIGHLIGHTS

- **MINIATURE**
- **HIGH DENSITY**
- **TRIPLE OUTPUT**
- **DC/DC CONVERTER**
- **UP TO 50W**

## Applications

Military, Ruggedized, Telecom, Industrial

## Special Features

- Miniature size
- High efficiency
- Wide input range
- Input / Output isolation
- Fixed switching frequency (250 kHz  $\pm$  10 kHz)
- External synchronization capability
- TTL logic enable (Inhibit)
- EMI filters included
- Indefinite short circuit protection with auto-recovery
- Over-voltage protection
- Over temperature shutdown with auto-recovery

## Environmental Conditions

Meets or exceeds MIL-STD-810D

### Temperature:

Operating:  $-55^{\circ}\text{C}$  to  $+85^{\circ}\text{C}$  (baseplate)

Storage:  $-55^{\circ}\text{C}$  to  $+125^{\circ}\text{C}$

### Vibration:

Operational, random, 15-2000 Hz, 13.71  $\text{g}_{\text{rms}}$ , 1hr, 3 perpendicular axes

### Mechanical Shock:

- 100 g, 6 ms, Half sine
- 30 g, 11 ms, Half sine

## Reliability

Over 288,000 hours at  $+50^{\circ}\text{C}$  baseplate;  
Over 150,000 hours at  $+85^{\circ}\text{C}$  baseplate;  
Calculated per MIL-STD-217F Notice 2,  
Airborne Uninhabited Fighter (AUF)  
environment.

## Electrical Specifications

### DC Input

DC Input range: 18 to 48  $\text{V}_{\text{DC}}$

### Input transient protection:

All models meet or exceed (no damage)

MIL-STD-1275A (100 V for 50 ms) and

MIL-STD-704A, MIL-STD-704D (80 V for 0.1 s)

Efficiency: up to 80%

EMC: Designed to meet\* MIL-STD-461F

CE101, CE102, CS101, CS114, CS115,

CS116, RE101, RE102, RS101, RS103

### Isolation:

Input to Output: 200  $\text{V}_{\text{DC}}$

Input to Case: 200  $\text{V}_{\text{DC}}$

### DC Outputs (floating from each other)

### Line/Load regulation:

Up to  $\pm 1\%$  (no load to full load,  $-55^{\circ}\text{C}$  to  $+90^{\circ}\text{C}$   
and over input voltage range)

Ripple and Noise: 50  $\text{mV}_{\text{p-p}}$ , typical (max. 1%)

### Current limiting (Hiccup):

Continuous protection for unlimited time

### Over voltage protection:

Passive transorb on outputs.

### Over temperature protection:

Shutdown at baseplate temperature above  
 $+105^{\circ}\text{C} \pm 5^{\circ}\text{C}$ . Automatic recovery at baseplate  
temperature below  $+95^{\circ}\text{C} \pm 5^{\circ}\text{C}$ .

### Isolation:

Output and Case: 100  $\text{V}_{\text{DC}}$

\* Compliance achieved with 5 $\mu\text{H}$  LISN, shielded  
harness and static resistive load.

**8737 SERIES DC/DC POWER SUPPLY**

**Operational Block Diagram**

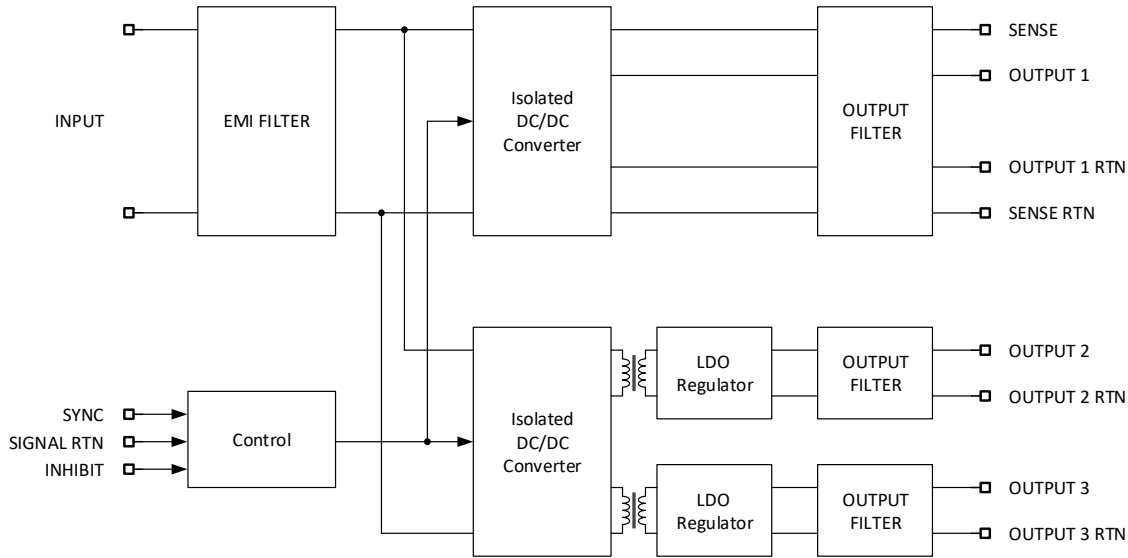

**Outputs Range**











Output #	Voltage Range	Current Range	Power Range
1	1.8 to 70 V <sub>DC</sub>	0 to 10 A	0 to 45 W
2	2.5 to 24 V <sub>DC</sub>	0 to 2.5 A	0 to 20 W
3	2.5 to 24 V <sub>DC</sub>	0 to 1.25 A	0 to 20 W
<b>Total</b>			0 to 50 W











## 8737 SERIES DC/DC POWER SUPPLY

### Pin Assignment

**Connector type:** Airborn RM272-020-312-2900 or eq.

**Mates with:** Airborn RM242-020-241-5900 (solder cup terminations) or RM242-020-571-5900 (#20-22 AWG crimp contacts) or eq.

Pin No.	Function	
1	OUT 2 (+)	
2	OUT 3 (+)	
3	OUT 3 RTN (-)	
4	VIN (+)	
5	VIN (+)	
6	SENSE 1 (+)	
7	VIN RTN (-)	
8	OUT 1 (+)	
9	OUT 1 (+)	
10	OUT 1 RTN (-)	

Pin No.	Function	
11	OUT 2 RTN (-)	
12	SYNC IN	
13	CHASIS	
14	INHIBIT	
15	SIGNAL RTN	
16	VIN RTN (-)	
17	SENSE 1 RTN (-)	
18	OUT 1 (+)	
19	OUT 1 RTN (-)	
20	OUT 1 RTN (-)	

**Note:**

1. The SIGNAL RTN is referred to the input.
2. SINGAL RTN is the return path for SYNC IN and INHIBIT signals

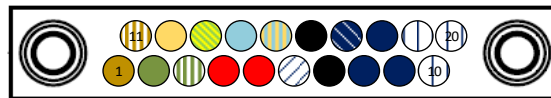

## Functions and Signals

### **INHIBIT signal**

The **INHIBIT** signal is used to turn the power supply ON and OFF.

TTL “1” or OPEN – will turn the power supply ON (For normal operation leave the signal not connected).

TTL “0” or short– will turn the power supply OFF.

This signal is referenced to the **SIGNAL RTN** pin.

### **SYNC IN signal**

The **SYNC IN** signal is used to allow the power supply frequency to sync with the system frequency.

The system frequency should be 250 kHz  $\pm$  10 kHz.

When not connected the power supply will work at 250 kHz  $\pm$  10 kHz.

This signal is referenced to the **SIGNAL RTN** pin.

### **SIGNAL RTN**

The **SIGNAL RTN** pin is used as a return path for **SYNC IN** and **INHIBIT** signals.

This pin is referenced to the **VIN RTN** pin.

### **SENSE 1**

The **SENSE 1** is used to achieve accurate load regulation at output #1's load terminals. This is done by connecting the pins directly to the load terminals. The remote sense correction function is limited to voltage drop between converter's output and load terminals of 2% to 5%, or up to 0.5V, the least of the two.

When not used, connect **SENSE 1** to **OUT 1** and **SENSE 1 RTN** to **OUT 1 RTN**. These pins can be tied internally if not required, to avoid adding this external connection – *consult factory*.

**8737 SERIES DC/DC POWER SUPPLY**

**Outline Drawing**

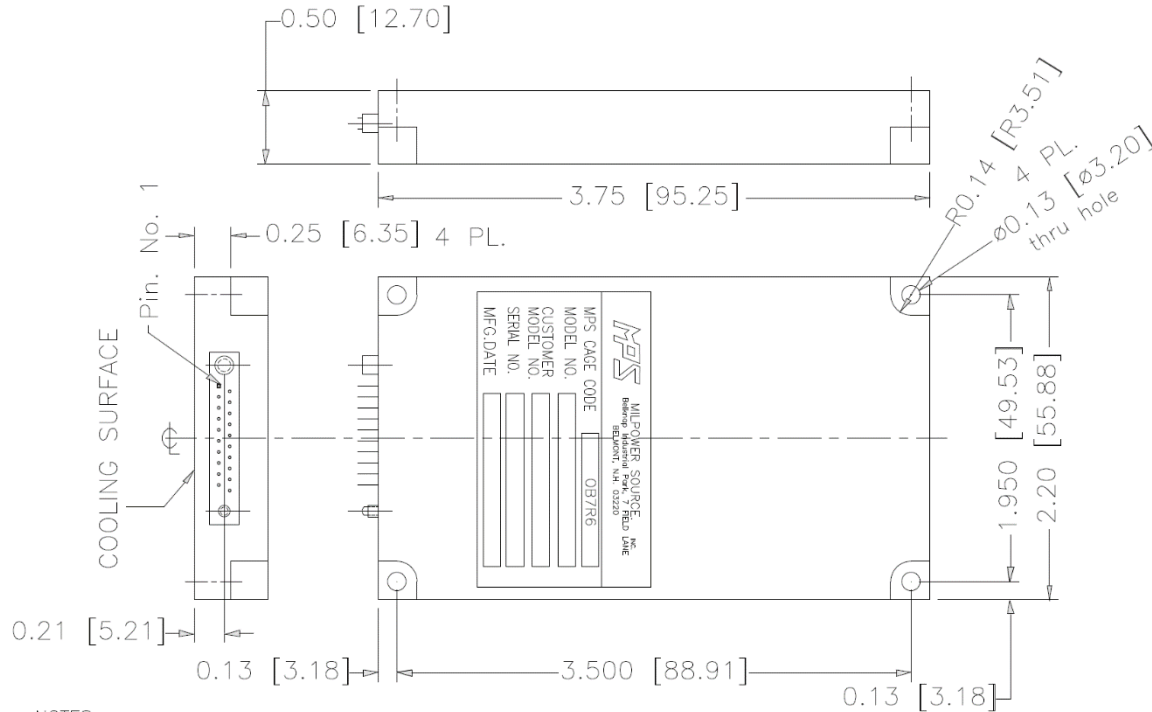

**NOTES:**

1. MTL. AL 6061-T651 PER QQ-A-250/11
2. CONVERSION COATING PER MIL-C-5541 CL 1A

**Heat Dissipation Surface**

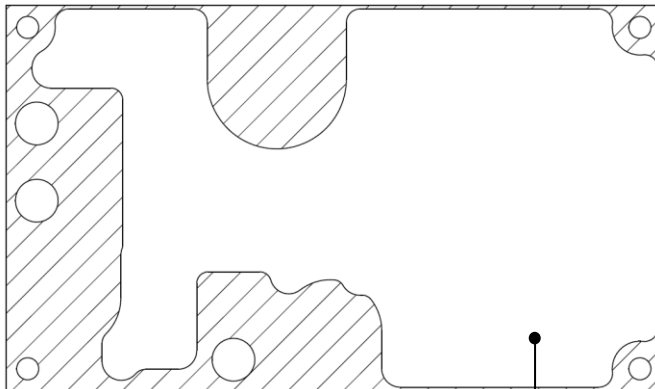

**Dissipation Area**  
2.5785 in<sup>2</sup>  
(1663.5 mm<sup>2</sup>)

Notes

1. Dimensions are in Inches [mm]
2. Tolerance is:  
.XX ±0.01 IN  
.XXX ±0.005 IN
3. Weight: Approx. 4.4 oz (125 g)

**Specifications are subject to change without prior notice by the manufacturer.**