

M4701 SERIES

AC/DC POWER SUPPLY



PRODUCT HIGHLIGHTS

- VITA 62 COMPLIANT
- 6U VPX FORM FACTOR
- SOSA™ ALIGNED
- AC/DC CONVERTER
- Up to 1200W Steady State
- 1500W Peak Power
- Cyber Secure



Applications

Military (Airborne, ground-fix, shipboard), Ruggedized, Telecom, Industrial

Special Features

- VITA 62 6U
- SOSA™ Aligned
- High efficiency
- Input / Output isolation
- Remote sense
- EMI filters included
- Fixed switching frequency
- Parallel configuration
- 46.11 Tier 2 communication
- External Inhibit & Enable
- Indefinite short circuit protection with auto-recovery
- Over temperature shutdown with auto recovery

Electrical Specifications

<p>DC Input 115V_{AC} ± 10% 400Hz Three-Phase Ride-through Mil-STD-704F normal transient</p> <p>Line/Load regulation ±1% or better (no load to full load, low line to high line (-55°C to 85°C).</p> <p>Ripple and Noise Less than 50mV_{p-p}, typical (max. 1%), measured across 0.1µF and 10µF on Load</p> <p>System Management Options 1) I2C 2) VITA 46.11 Tier I IPMC 3) VITA 46.11 Tier II IPMC Data available: • Output voltages and currents • Input voltage • Card temperature • Card status</p>	<p>DC Outputs PO1/PO2/PO3 12V/100A 3.3V_{Vaux} 3.3V/30A ±12V_{Vaux} - Optional</p> <p>Total Steady state Power 1200W (-55°C to +85°C). Peak Power 1500W ¹</p> <p>Hold Up N/A</p> <p>Current Share 12V Active Current share 3.3V_{Vaux} Passive Current Share (3.3V_{Vaux} ACS optional)</p> <p>Load Transient Output dynamic response up to 5% at step load of 30%-90%. Output return to steady stated within 300-500µSec</p> <p>Power Factor ≥ 0.87 (Full load) ³</p>	<p>Isolation 500V_{DC} Input to Output 500V_{DC} Input to Case 500V_{DC} Output to Case</p> <p>EMC Designed to meet with External Filter MIL-STD-461F ² CE102, CS101, CS114, CS115 & CS116, RE102</p> <p>Efficiency Typical 87% (Nominal line, nominal load, room temperature)</p>
---	---	--

Notes:

¹ Contact Factory for peak power options

² Deviation under 70KHz, See EMI Paragraph. RE102 Supported at system Level

³ P.F Leading, lagging optional with external Filter

Protections (Thresholds and protections can be modified / removed – please consult factory).

<p><u>Input</u></p> <ul style="list-style-type: none"> • Inrush Current Limiter: peak value of $5 \times I_{IN}$ for inrush currents lasting longer than 100μs. • Under Voltage Lock-Out Unit shuts down when input voltage is below $70V_{AC_{RMS}} \pm 5V_{AC_{RMS}}$. • Catastrophic Failure Protection Fuses are available to protect from catastrophic failure. The fuses are rated not to engage due to any normal type operation. 	<p><u>Outputs</u></p> <ul style="list-style-type: none"> • Over Voltage Protection: 12V Active & Passive OVP 3.3Vaux Active & Passive OVP $\pm 12V_{aux}$ Active & Passive OVP • Overload / Short Circuit Protection 12V Output-Continuous Hiccup protection (110-130%). 3.3Vaux – Typical 33A $\pm 12V_{aux}$ – Typical 3A 	<p><u>General</u></p> <ul style="list-style-type: none"> • Over temperature Protection: Shutdown at $+100\text{ }^{\circ}\text{C} \pm 5^{\circ}\text{C}$ Recovery at $+90\text{ }^{\circ}\text{C} \pm 5^{\circ}\text{C}$ Temperature measured at Unit edge.
--	--	--

<p><u>Environmental</u> Designed to meet MIL-STD-810G and VITA 47</p>		
<p><u>Temperature</u> Operating: -55°C to $+85^{\circ}\text{C}$ (at plug-in card edge, IAW VITA 62 CC4) Storage: -55°C to $+125^{\circ}\text{C}$</p> <p><u>Humidity</u> 810G Method 507.5 & VITA 47 Para. 5.6, Up to RH 95%.</p> <p><u>Reliability</u> > 314,000 hours, calculated per MIL-STD-217F Notice 2 at $+65^{\circ}\text{C}$ at wedge lock edge, Ground Fixed.</p>	<p><u>Altitude</u> 810G Method 500.5, Procedure II (Operational) & VITA 47 para. 5.7 60,000 ft.</p> <p><u>Vibration</u> 810G Method 514.6 Procedure I. General minimum integrity exposure. (1 hour per axis & VITA 47 Vibration Class V3</p>	<p><u>Salt Fog</u> Method 509.5</p> <p><u>Shock</u> 810G Method 516.6 Procedure I & VITA 47 Shock Class OS2 Saw-tooth, 40g peak, 11ms</p>

Environmental Stress Screening (ESS)

Including random vibration and thermal cycles is also available. **Please consult factory for details.**

Functions and Signals (according to VITA 62.0)

Signal Name	Type	Description
FAIL*	Output	Indicates to other modules in the system that a failure has occurred in one of the outputs. Please refer to Figure 2
SYSRESET*	Output	Indicates to other modules in the system that all outputs are within ¹ their working level. Please refer to Figure 2
INHIBIT*	Input	Controls power supply outputs. This signal in conjunction with Enable controls the outputs. Please refer to Table 1 and Figure
ENABLE*	Input	Controls power supply outputs. This signal in conjunction with INHIBIT controls the outputs. Please refer to Table 1 and Figure 1
GA0-4*, GAP**	Input	Used for geographical addressing. GA2 is the most significant bit and GA0 is the least significant bit.
SCL, SDA	Bidirectional	I2C bus Clock and Data respectively. Through this bus the voltage and temperature readouts can be shared.
Sync In	Input	The Sync signal is used to allow the power supply frequency to sync with the system frequency. (Optional)
Sync Out	Output	Send Internal switching frequency. (Optional)
VOUT SENSE	Input	The SENSE is used to achieve accurate load regulations at load terminals (this is done by connecting the pins directly to the load's terminals).
Alert Bit	Output	Indicates to other modules in the system about Input Voltage loss. Please refer to Figure 2
12V_Share	Bidirectional	Support current share between Outputs. Two pins required. ^{1 2}
3.3Vaux Share	Bidirectional	Support Active current share between Outputs. See Current Share para. ^{1 2}
3.3Vaux ACS	Bidirectional	Support Active current share between Outputs. See Current Share para. ^{1 2 3}

Notes:¹ All Signals referenced to **SIGNAL RTN**² When not used leave open³ Non-SOSA™ configuration

Table 1 – Inhibit and Enable Functionality

INHIBIT*	Low	Low	High	High
ENABLE*	Low	High	Low	High
12V Output	OFF	OFF	ON	OFF
3.3V_AUX	ON	OFF	ON	OFF

Figure 1 – Inhibit and Enable Input stage

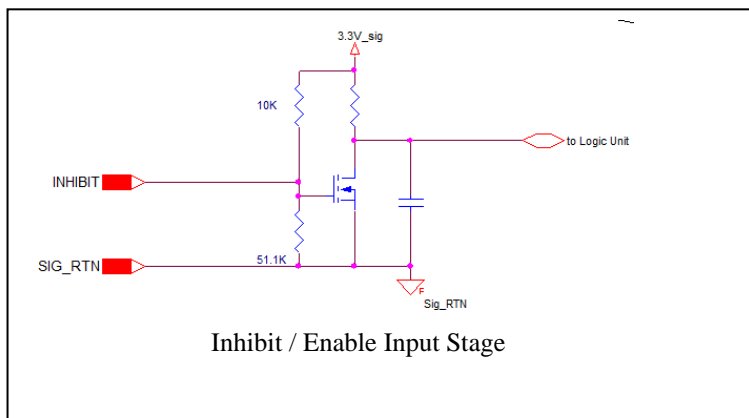
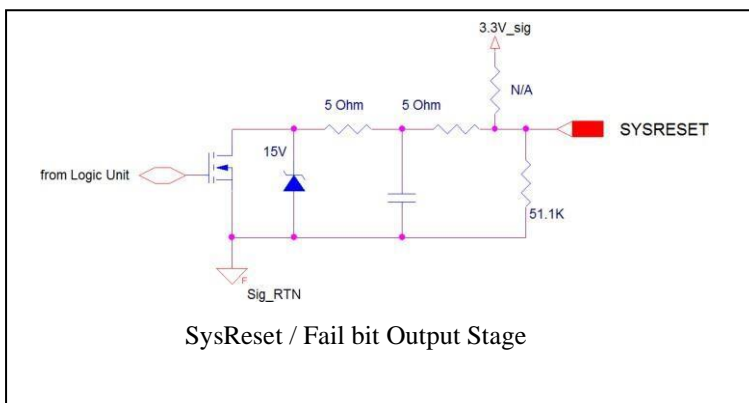

Figure 2 – SysReset and Fail Bit Output Stage



Detailed Information

1. Input Voltage Operation.

The M4701 steady state operation is per Mil-STD-704. Unit will work through all Normal Transients per Mil-STD-704 B to F, protected to all other transients and interrupts.

2. Outputs Voltage Regulation

The M4701 contains accurate internal sense lines to keep output voltage at less than 3% regulation for all Line / Load and temperature range (see Table 2).

Output	12V Output	3.3Vaux Output
Voltage Range	11.85 – 12.15	3.25 – 3.4

Table 2: Outputs voltage regulation. Temperature -55°C – 85°C

2.1 Sense Lines

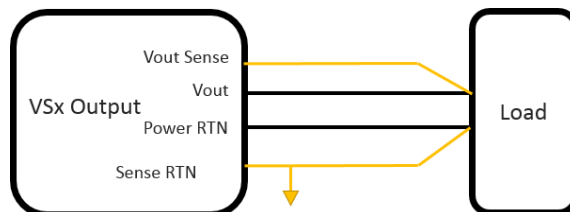

Figure 3: M4701 Sense line connection

2.2 Holdup

N/A

3. Current Share (C.S)

Current Share of two or more units is optional (Contact Factory)

12V output and 3.3VAux will current share with about 2-4A load balance.

3.1 Active Current Sharing (A.C.S)

Current share done in a closed-loop. All paralleled outputs are compared and feedback is used to balance their load current. The result is a more stable, less sensitive output voltage without voltage drop. Typical Load Balance of about 1 to 4A for all Load range is expected.

ACS is supported by the 12V output. Optional for 3.3Vaux^{1 2}.

3.2 3.3Vaux Passive current sharing (P.C.S)

Current sharing is done in open loop, output voltage drops as a function of output load.

Load Balance of about 5-10% is expected. 3.3Vaux ACS is optional^{1 2}

3.3 Current share connection between two Units.

For a required output to current share please connect the following Pins between the two units

- *PO#_Sense* & *PO#_Sense_RTN* (for best performance, Pins from paralleled units should be connected to a single point and as close as possible to the load point)
- Connect A7 and B7 for 12V ACS
- Connect C7 for 3.3aux PCS
- Connect B1 for 3.3Vaux ACS -(Optional, not per SOSA pinout. This pin is internally N.C if not ordered)

When not used, all share pins can be left open.

Typical ACS Dynamic Load of Two 12V Paralleled Outputs

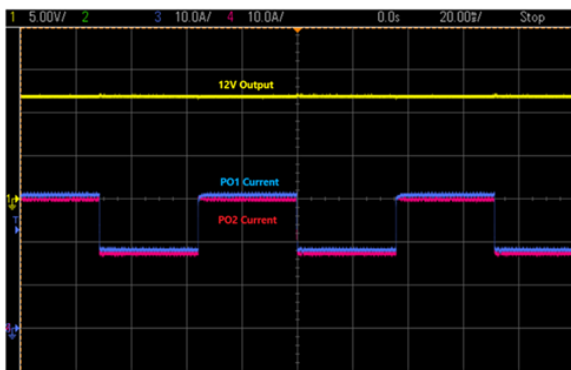

Notes:

¹ When Not used, share pins can be left open.

² When ordering 3.3Vaux P.C.S or Non-Current Share unit, those pins are Internally disconnected

4. EMI CE102 tests

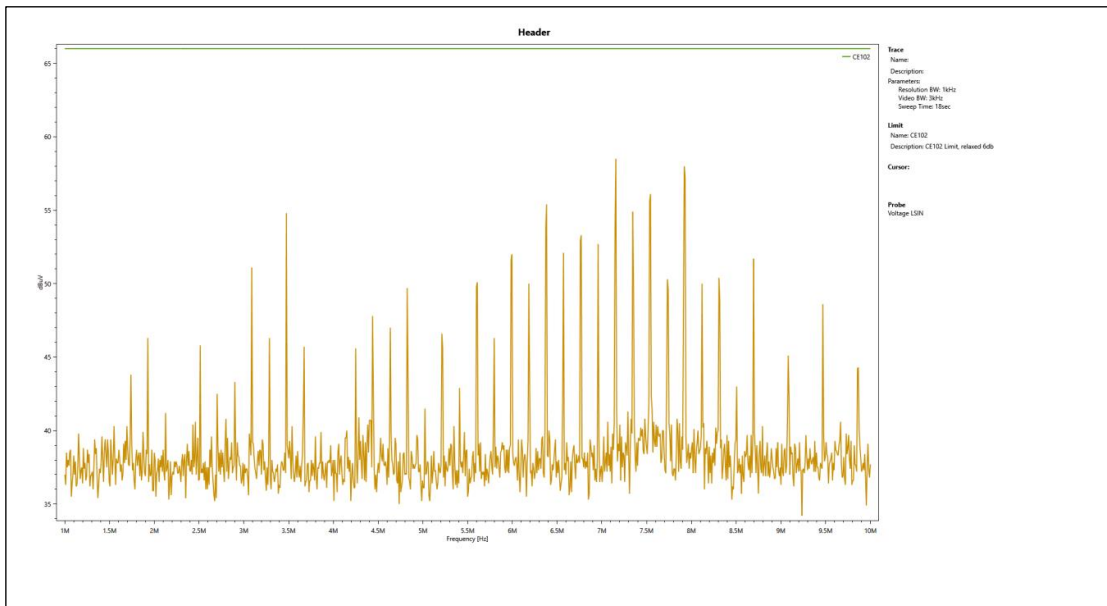
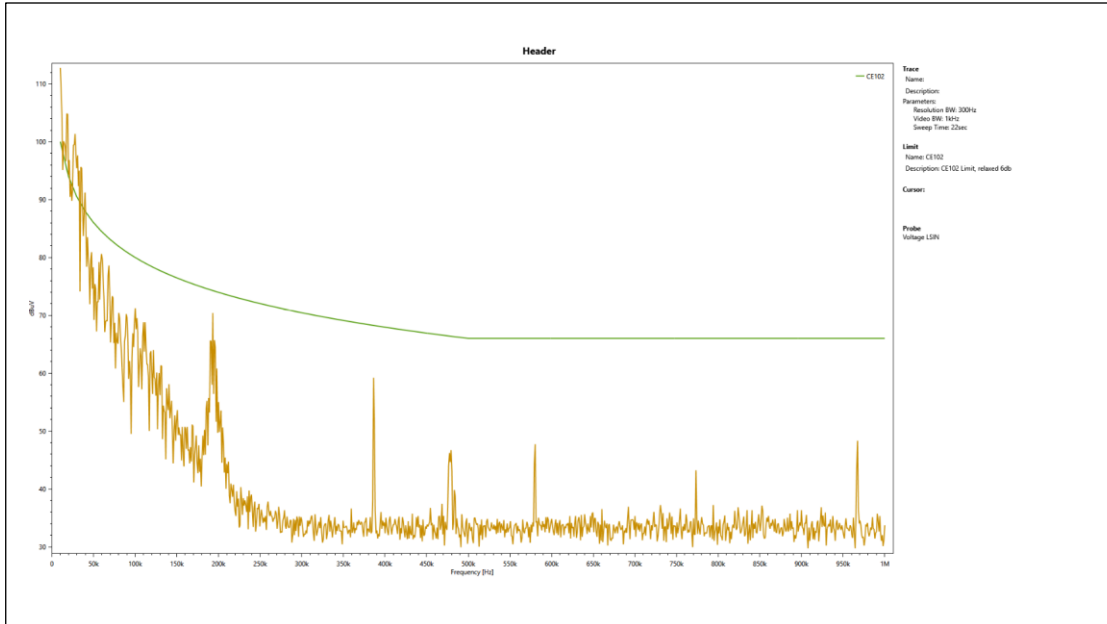

5. Communication Protocol

Unit communication protocol can be configured as VITA 46.11 Tier 2 IPMC, VITA 46.11 Tier 1 IPMC or Advanced I2C protocol. For more details on protocols refer to para. 5.1 and 5.2.

5.1 Advanced I2C Protocol

Electrical Parameters

Vcc: 3.3VDC
 Pull-up: 20kOhm
 Input capacitance: 100pf

Slave Device Addressing

- 256 address spaces
- Baud rate: 200kHz maximum
- 7 Bit Protocol
- Support Slot Addressing per VITA 62

Slot Number	MSB							LSB
	A6	A5/*GAP	A4/*GA41	A3/*GA3	A2/*GA2	A1/*GA1	A0/*GA0	R/W
Slot0	1	0	0	0	0	0	0	
Slot1	1	0	0	0	0	0	1	
Slot2	1	0	0	0	0	1	0	
Slot3	1	0	0	0	0	1	1	

* Slot location is determined by GAX per VITA 62.

Communication Supported

Read Command – 21Hex, deliver 64Bytes of Data. (More commands are available by request)
 The communication starts when the master sends a start followed by the unit slave address, command, checksum and a stop. A second start followed by the slave address and a read will be followed by a 64 Bytes response.

S	Slave Address	R/W	A	Command	A	Check sum	A	P
	A6:A0	0	0	21 Hex	0	DF Hex	0	

S	Slave Address	R/W	A	DATA	A	DATA	A	DATA	A	...	DATA	A	Check sum	N/A	P
	A6:A0	1	0	D7:D0	0	D7:D0	0	D7:D0	0		D7:D0	0	D7:D0	1	

Command – 21Hex read all 64 Bytes
 S - Start
 P - Stop

Master Transmit	Unit Transmit

5.2 VITA 46.11 Tier 1 and Tier 2 IPMC

Please see *46.11 User Manual* for detailed information of operation. Sensors included are seen in the table below

Record ID	Sensor ID	Sensor Type	Name
0000	00	F0h	FRU State Sensor
0001	01	F1h	System IPMB Link Sensor
0002	02	F2h	FRU Health Sensor
0003	03	02h	FRU Voltage Sensor
0004	04	F3h	FRU Temperature Sensor
0005	05	F4h	Payload Test Results Sensor
0006	06	F5h	Payload Test Status Sensor
0100	07	02h	VS1 Voltage
0103	0A	02h	3.3VAux Voltage
0106	0D	03h	VS1 Current
0109	10	03h	3.3VAux Current
010C	13	01h	Analog Temperature
9999	N/A	N/A	Device Management

Memory Space

Response Byte #	Data Type	Meaning	Interpretation	Reading Range
0	U Integer, MSB First	Echo of Command		21 Hex
1	U Integer, MSB First	N/A		00 Hex
2	S Integer, MSB First	Temperature	T(C°)=+/- 7bit Dec	-55 to 125 °C
3	U Integer, MSB First	Reserved	00Hex	
4-5	U Integer, MSB First	PO1 12V Voltage	V(out) = Data/ m2	20.48V
6-7	U Integer, MSB First	PO2 12V Voltage	V(out) = Data/ m2	20.48V
8-9	U Integer, MSB First	PO3 12V Voltage	V(out) = Data/ m2	20.48V
10-11	U Integer, MSB First	3.3V Aux Voltage	V(out) = Data/ m2	20.48V
12-13	U Integer, MSB First	12VAux Voltage	V(out) = Data/ m2	Optional
14-15	U Integer, MSB First	(-)12V Aux Voltage	V(out) = Data/ m2	Optional
16-17	U Integer, MSB First	12V Total Current	V(out) = Data/ m3	40A
18-19	U Integer, MSB First	12V Total Current - Copy	V(out) = Data/ m3	40A
20-21	U Integer, MSB First	12V Total Current - Copy	V(out) = Data/ m3	40A
22-23	U Integer, MSB First	3.3VAux Current	V(out) = Data/ m5	20A
24-35	U Integer, MSB First	12V Aux Current	V(out) = Data/ m4	Optional
26-27	U Integer, MSB First	(-)12V Aux Current	V(out) = Data/ m4	Optional
28-29	U Integer, MSB First	Reserved	00Hex	
30-31	U Integer, MSB First	Reserved	00Hex	
32-51	Character String (ASCII)	Part Number	M4701-xxx* (Note1)	20 Characters
52-53	Decimal, MSB First	Serial Number, 2MSB Dig	X,X Dec (Note2)	Optional
54-55	Decimal, MSB First	Serial Number, 2LSB Dig	X,X Dec (Note2)	Optional
56-57	Decimal, MSB First	Date Code	Week, Year (Note3)	Optional
58-59	Character String (ASCII)	Hardware Rev	B01 & B02 Boards (note4)	2 Characters
60-61	Decimal, MSB First	Firmware Rev	X,X,X,X Dec (Note5)	4 digits
62	U Integer, MSB First	Reserved		AA Hex
63	U Integer, MSB First	Zero Checksum	Value required to make the sum of bytes 0 to 62 added to a multiple of 256	

Note:

$M_2 = 20.48 / 2^{16-1}$

$M_3 = 40 / 2^{16-1}$

$M_4 = 10 / 2^{16-1}$

$M_5 = 20 / 2^{16-1}$

*Matching unit part number

Notes 1 to 5:

1. Part Number Example: M4065-4

Byte No'	32	33	34	35	36	37	38	39-51
Character	M	4	0	6	5	(-)	4	0
Hex	4D	34	30	36	35	2D	34	00

2. Serial Number Example: 25

Byte No'	52		53		54		55	
Dec Number	0	0	0	0	0	0	2	5
Binary	"0000"	"0000"	"0000"	"0000"	"0000"	"0000"	"0010"	"0101"

3. Date Code Example: week 35 of 2018

Byte No'	56		57	
Dec Number	3	5	1	8
Binary	"0011"	"0101"	"0001"	"1000"

4. Hardware Rev Example: B01 Rev (-), B01 Rev A

Byte No'	58	59
Character	(-)	A
Hex	2D	41

5. Firmware Rev Example: 2.1.0.0

Byte No'	60		61	
Dec Number	2	1	0	0
Binary	"0010"	"0001"	"0000"	"0000"

Pin Assignment

Connector P0

Connector type: 6450843-6 or eq.

Pin Number	Signal Name
P7	PHASE A
P6	PHASE B
P5	PHASE C
P4	
P3	
P2	
P1	CHASSIS_GND

Pin Number	Pin Name
P10	12V/35A (VS1, VS2)
P9	12V/35A (VS1, VS2)
A9	12V_SENSE
B9	12V_SENSE
C9	12V_SENSE
D9	Sync in
A8	12V_SENSE_RTN
B8	12V_SENSE_RTN
C8	12V_SENSE_RTN
D8	Sync Out
A7	PO1_SHARE
B7	PO2_SHARE
C7	PO3_SHARE
D7	SIGNAL_RETURN
P8	POWER_RETURN
P7	POWER_RETURN
A6	SCL_B
B6	SDA_B
C6	-12V_AUX / N.C
D6	SYSRESET*
A5	GAP*
B5	GA4*
C5	SCL
D5	SDA
A4	GA3*
B4	GA2*
C4	GA1*
D4	GA0*
A3	N.C
B3	+12V_AUX/N.C
C3	N.C
D3	N.C
P6	12V/35A (VS1, VS2)
P5	12V/35A (VS1, VS2)
P4	POWER_RETURN
P3	POWER_RETURN
A2	N.C
B2	FAIL*
C2	INHIBIT*
D2	ENABLE*
A1	N.C.
B1	3.3Vaux A_Share
C1	3.3Vaux Sense
D1	3.3Vaux Sense return
P2	3.3V/15A
P1	POWER_RETURN

Connector P1:

Connector type: 6450849-6or eq

Outline Drawing

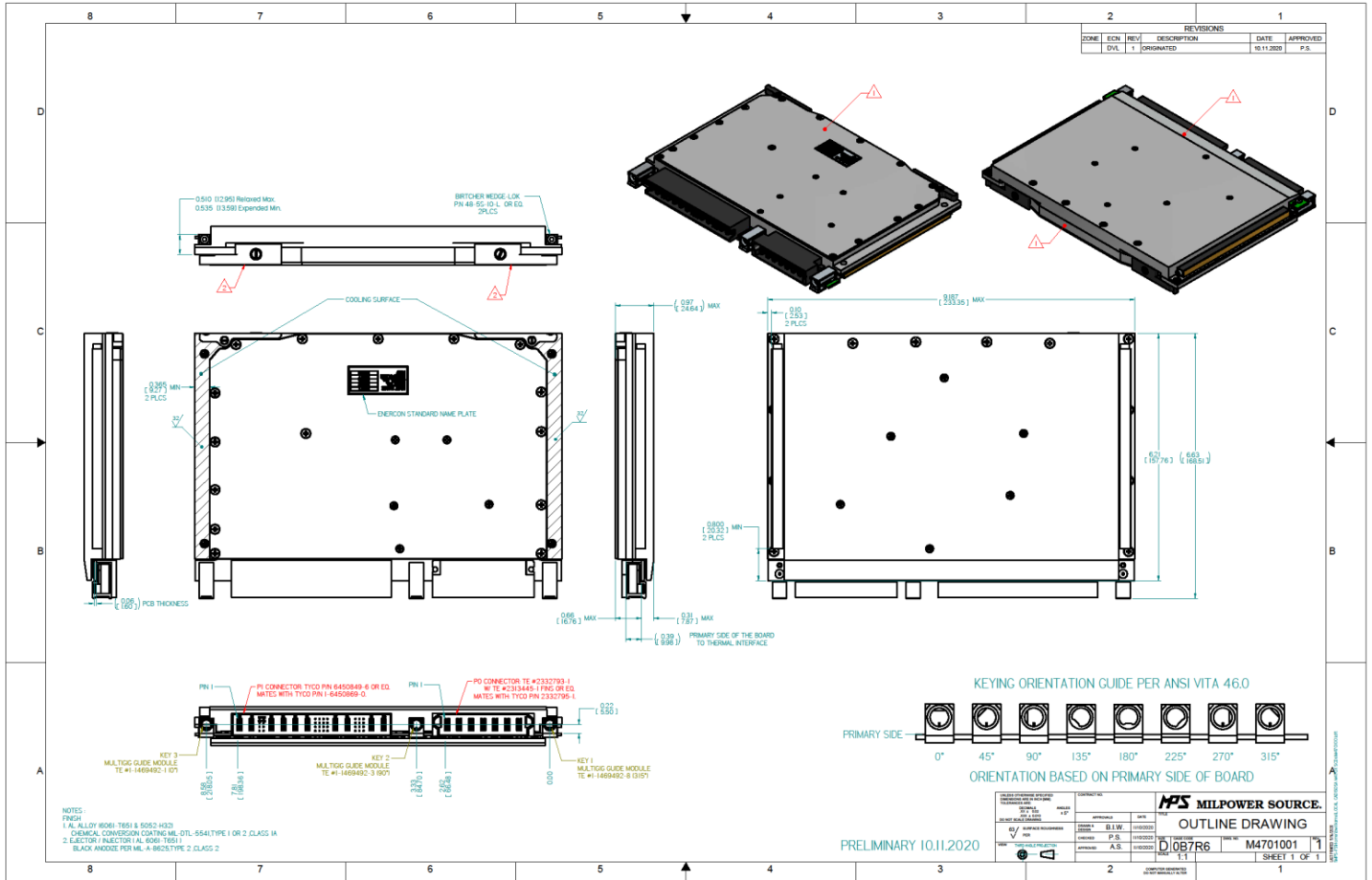

* Specifications are subject to change without prior notice by the manufacturer.