

M109 SERIES

SINGLE-OUTPUT, UP TO 1KW AC/DC POWER SUPPLY

The M109 is a series of mechanically robust, base plate cooled, high performance, 1kW single output AC to DC power supplies, for Navy shipboard, Airborne, and ground applications.

The M109 converts 115VAC 50-60/400Hz or 230VAC 50-60Hz, to a well-regulated, filtered and protected DC Output.



M109 Series– AC/DC Power Supply

THE MAIN FEATURES OF THE M109 ARE:

- AC/DC Single output power supply up to 1kW
- 115VAC 50/60/400 Hz or 230VAC 50/60 Hz Standard Input version, single-phase
- For extended input version - **Please contact factory for more details**
- Very low input THDA
- Near unity power factor (>0.99)
- Input / Output isolation
- EMI filters included
- Remote sense compensation
- Remote Inhibit (On/Off)
- Fixed switching frequency
- External sync capability
- Parallel connection option
- Inrush Current Limiter
- Non-latching protections:
 - Overload/Short-circuit
 - Output Overvoltage
 - Over Temperature
 - Input Undervoltage Lockout

M109 Series– AC/DC Power Supply

Standard Models List (for other voltages – consult factory)

Part number	Input	Output	
	Voltage range	Voltage	Current
M109-100	115V _{AC} / 50-400Hz / Single-phase	5 V _{DC}	70 A
M109-101	115V _{AC} / 50-400Hz / Single-phase	12 V _{DC}	70 A
M109-102	115V _{AC} / 50-400Hz / Single-phase	24 V _{DC}	42 A
M109-103	115V _{AC} / 50-400Hz / Single-phase	28 V _{DC}	36 A
M109-104	115V _{AC} / 50-400Hz / Single-phase	48 V _{DC}	21 A
M109-110	230V _{AC} / 50-60Hz / Single-phase	5 V _{DC}	70 A
M109-111	230V _{AC} / 50-60Hz / Single-phase	12 V _{DC}	70 A
M109-112	230V _{AC} / 50-60Hz / Single-phase	24 V _{DC}	42 A
M109-113	230V _{AC} / 50-60Hz / Single-phase	28 V _{DC}	36 A
M109-114	230V _{AC} / 50-60Hz / Single-phase	48 V _{DC}	21 A

Additional standard configurations available. **Contact factory for more details.**

- All of our products can be configured to comply with EU REACH regulations. **Contact factory for more details.**

M109 Series– AC/DC Power Supply

SPECIFICATIONS:

AC Input	<i>Voltage Range</i>	Option 1: 85-150VAC/50-400Hz/1 phase Option 2: 150-265VAC/50-60Hz/1 phase. For extended input version - Please contact factory for more details
	<i>Transients</i>	For option 1: 80Vac and 180Vac transients IAW MIL-STD-704
	<i>Isolation</i>	Input to Output: 1000 VDC Input to Case: 1000 VDC
	<i>Current Waveform</i>	Complies with the Harmonic Current limits of MIL-STD-1399-300B.
DC Output	<i>Rating</i>	See table on page 8
	<i>Voltage Regulation</i>	±1% (Nominal voltage range, from 10% load to full load, –40 °C to +85 °C at baseplate).
	<i>Remote Sense</i>	<p>SENSE (connector J2, pin 19) The SENSE line is used to achieve accurate voltage regulation at load terminals. To use this feature, connect this pin directly to load's positive terminal. If this function is not required, short SENSE pin to OUTPUT pins.</p> <p>SENSE RTN (connector J2, pin 18) The SENSE RTN line is used to achieve accurate voltage regulation at load terminals. To use this feature, connect this pin directly to load's negative terminal. If this function is not required, short SENSE RTN pin to OUT RTN pins.</p> <p>Note: For output voltage above 8V, the use of remote sense has a max limit of 0.25V voltage dropout between converter's output and load terminals. For output voltage below 8V, the use of remote sense has a max limit of 0.5V voltage dropout between converter's output and load terminals. When not used connect SENSE to OUT and SENSE RTN to OUT RTN.</p>
	<i>Ripple and Noise</i>	(max. 1%) measured at load across 1 μF and 0.1 μF ceramic capacitors.
	<i>Isolation</i>	Output to Case: 200 V _{DC}
	<i>Current Limit & Overload</i>	Overload / Short-Circuit (HIC-UP) The converter shuts down (H.C) and restarts periodically while fault condition exists. Threshold set 120% ± 10% above maximum current
	<i>Efficiency</i>	87% typical (nominal line voltage, full load, room temperature)

M109 Series– AC/DC Power Supply

	<p><i>Overvoltage Protection</i></p>	<p>Over-Voltage active Internal control shuts output down (H.C) if voltage exceeds 110% ± 5% of nominal.</p> <p>Over-Voltage Passive Passive transorb, chosen at 125% ± 5% of nominal voltage.</p>
	<p><i>Over Temp. Protection</i></p>	<p>The converter shuts down if baseplate temperature exceeds +105 °C ± 5 °C. Automatic recovery upon cool down to below +95 °C ± 5 °C.</p>

M109 Series– AC/DC Power Supply

Specifications (Cont.):

Control & Indication	<i>INHIBIT Input</i>	<p><u>INHIBIT</u> (connector J2, pin 20) The <i>INHIBIT</i> signal is used to turn the power supply ON and OFF. TTL “1” or OPEN – Power supply active (output turned on). TTL “0” or SHORT to Signal RTN – Power supply inhibited (output turned off). If this function is not required, leave this pin unconnected. This signal is referenced to <i>SIGNAL RTN</i> (connector J2, pin 21)</p>
	<i>SIGNAL RTN</i>	<p><u>SIGNAL RTN</u> (connector J2, pin 21) The SIGNAL RTN is a reference ground for the control signals <i>SYNC IN</i>, <i>SYNC OUT</i> and <i>INHIBIT</i>. This ground is floating from other parts of the power supply.</p>
	<i>SYNC IN</i>	<p><u>SYNC IN</u> (connector J2, pin 62) The <i>SYNC</i> signal is used to synchronize the power supply's switching frequency to system's clock. Valid external clock frequency is 250 kHz ± 10 kHz. If this function is not required, leave this pin unconnected - the power supply will use its internal clock. This signal is referenced to <i>SIGNAL RTN</i> (connector J2, pin 21)</p>
	<i>SYNC OUT</i>	<p><u>SYNC OUT</u> (connector J2, pin 42) The <i>SYNC OUT</i> signal is a buffered clock with the same frequency as that of the converter's actual switching frequency of 250 kHz ± 10 kHz. This signal can be used to synchronize other power supplies in the system in a master-slave setup. This signal is referenced to <i>SIGNAL RTN</i> (connector J2, pin 21)</p>
Environment Designed to meet MIL-STD-810F	<i>Temperature</i>	<p>Methods 501.5 & 502.5 Procedure I (storage): –55 °C to +125 °C (ambient) Procedure II (operation): –40 °C to +85 °C (at baseplate)</p>
	<i>Humidity</i>	<p>Method 507.5 Up to 95% RH</p>
	<i>Salt-fog</i>	<p>Method 509.5</p>
	<i>Altitude</i>	<p>Method 500.5 Procedure I – Storage/Air transport: Up to 70 000 ft Procedure II – Operation/Air Carriage: Up to 40 000 ft</p>
	<i>Mechanical Shock</i>	<p>Method 516.6 Procedure I - Functional Shock Terminal peak sawtooth pulse, 20 g peak, 11 ms</p>

M109 Series– AC/DC Power Supply

	Vibration	<p><u>Vibration (Random)</u> Method 514.6 Procedure I Category 24 - General minimum integrity exposure</p> <p><u>Vibration (Shipboard Equipment)</u> Method 528 Type I</p>
	Fungus	Does not support fungus growth, in accordance with the guidelines of MIL-STD-454, Requirement 4-
EMI	MIL-STD-461F	Designed to meet* MIL-STD-461F CE101, CE102, CS101, CS114, CS115, CS116, CS109, RE101, RE102 RS101, RS103, RS105
Reliability	100,000 hours, calculated per MIL-STD-217F Notice 2 at +85 °C baseplate, Ground Fixed. 60,000 hours, calculated per MIL-STD-217F Notice 2 at +85 °C baseplate, Naval Sheltered.	
Cooling Requirements	The M109 is a baseplate cooled unit. The base of the M109 should be thermally attached to asuitable heatsink that maintains it below +85 °C.	
Form factor	5.51" wide, 1" high and 9.84" deep. For detailed dimensions and tolerances see Drawing: M109001	
Weight	Estimated weight 1.6kg	
Connectors	See Page 12-13	

*Compliance achieved with shielded harness and static resistive load.

M109 Series– AC/DC Power Supply

TYPICAL STAND-ALONE CONNECTION DIAGRAM

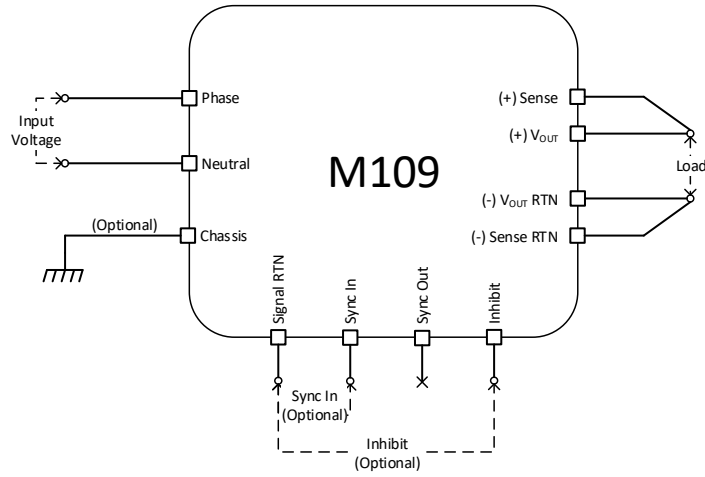

M109 Series– AC/DC Power Supply

TYPICAL PARALLEL CONNECTION DIAGRAM

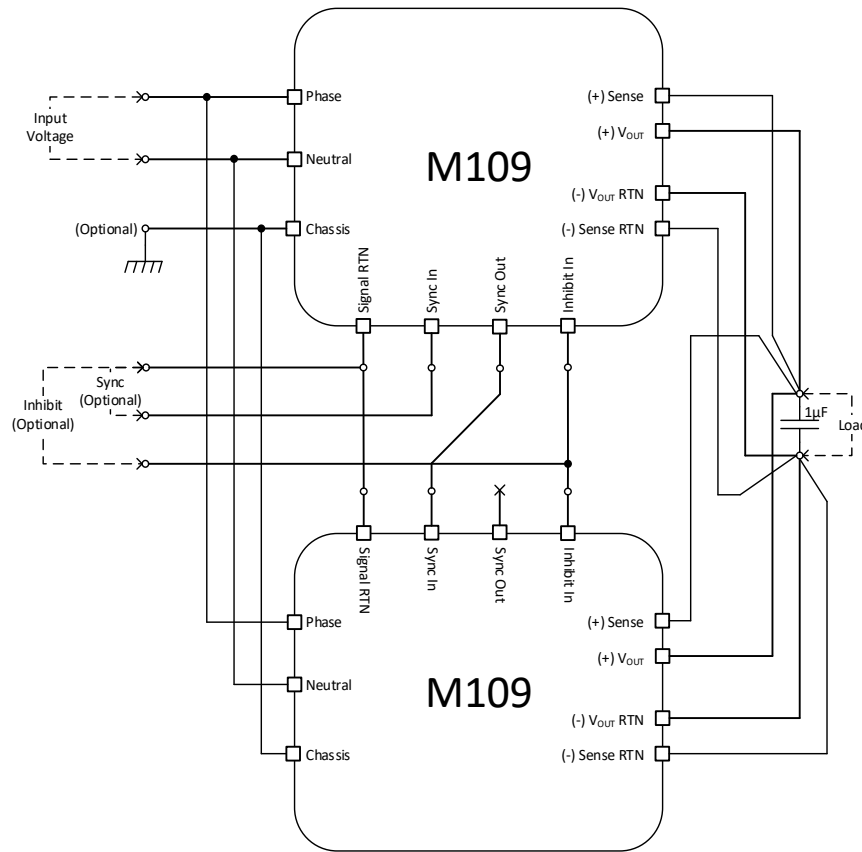

Note: Parallel operation via output voltage droop. Voltage regulation is $\pm 2\%$.

Outputs Range

Output #	Voltage Range	Current Range	Output Regulation	Power Range
1	3.3 - 50V _{DC}	0 to 70 A	$\pm 1\%$	0 to 1 kW
Total				0 to 1 kW

HIGHLIGHTS AND TYPICAL CHARACTERISTICS

INPUT CURRENT HARMONICS

Input: 115 V_{AC} / 60 Hz , Output: 28 V_{DC} / 36 A (1 000 W)

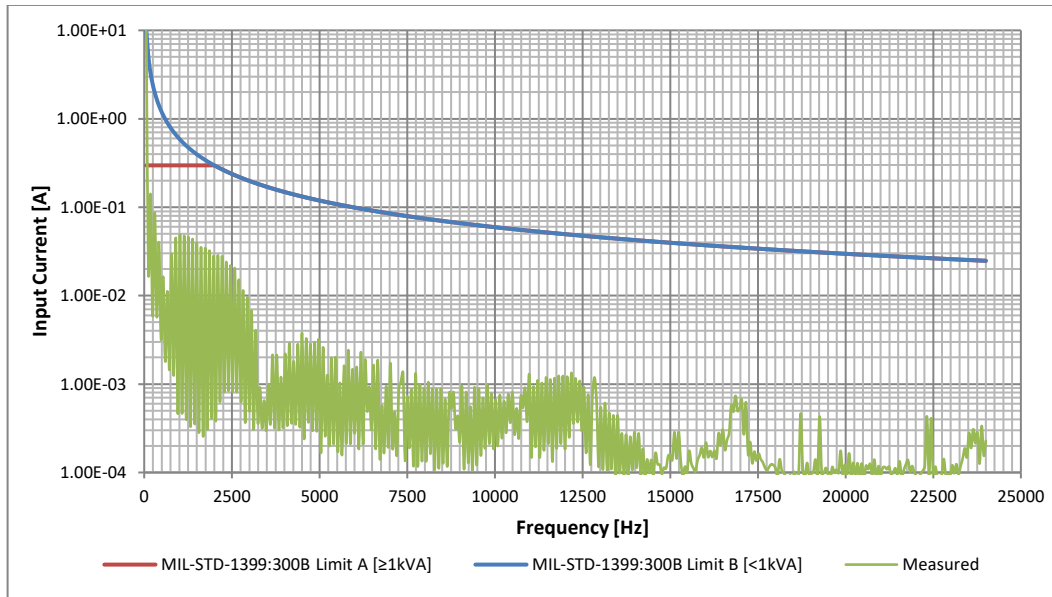

Input: 115 V_{AC} / 400 Hz , Output: 28 V_{DC} / 36 A (1 000 W)

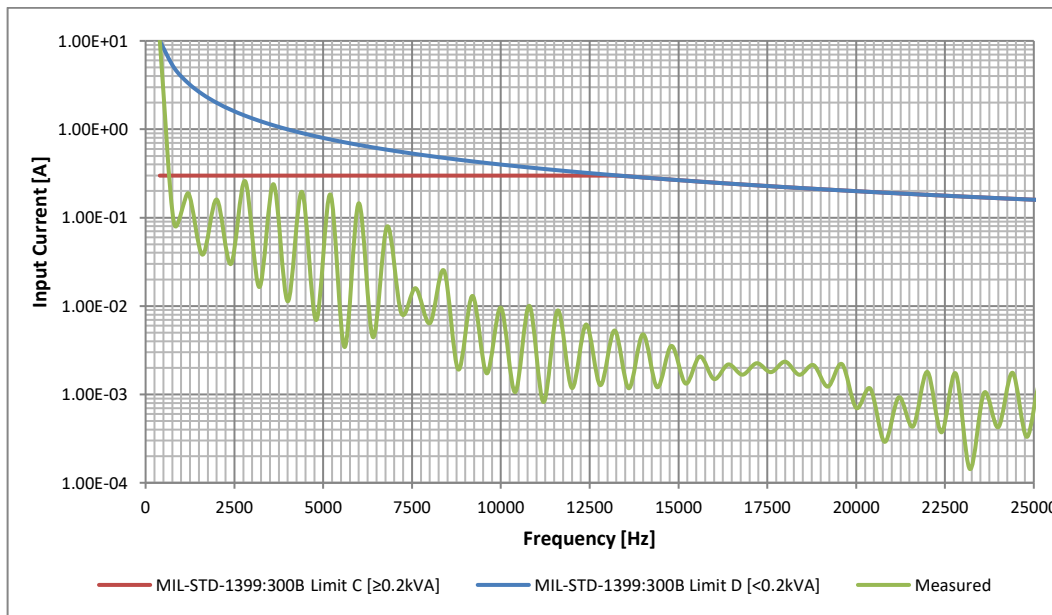

M109 Series– AC/DC Power Supply

POWER FACTOR AND INPUT CURRENT TOTAL HARMONIC DISTORTION (THDA)

Output: 28 V_{DC} / 36 A (1000 W)

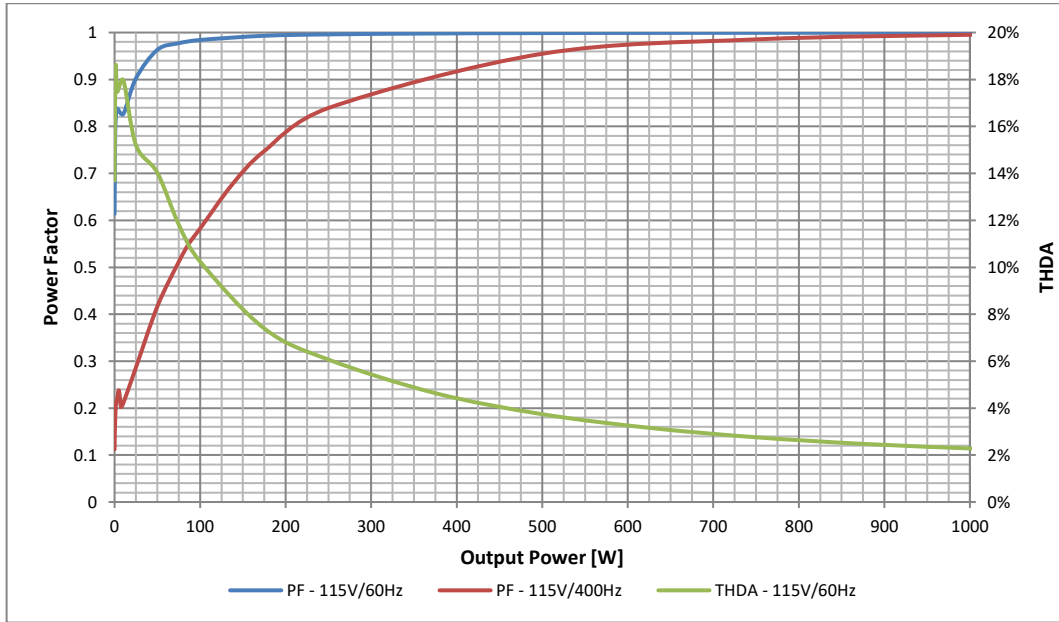

EFFICIENCY AND LOSS

Output: 28 V_{DC} / 36 A (1000 W)

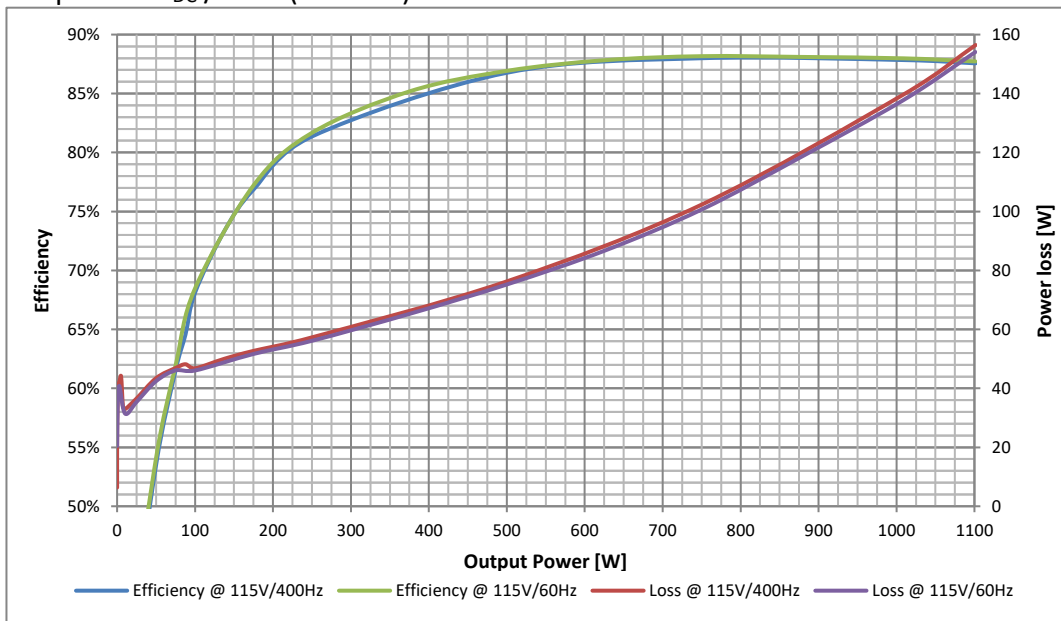

M109 Series— AC/DC Power Supply

CONDUCTED EMISSIONS (IAW MIL-STD-461F)

Input: 115 VAC / 400 Hz , Output: 28 VDC / 36 A (1000 W)

CE101 - 30 Hz to 10 kHz:

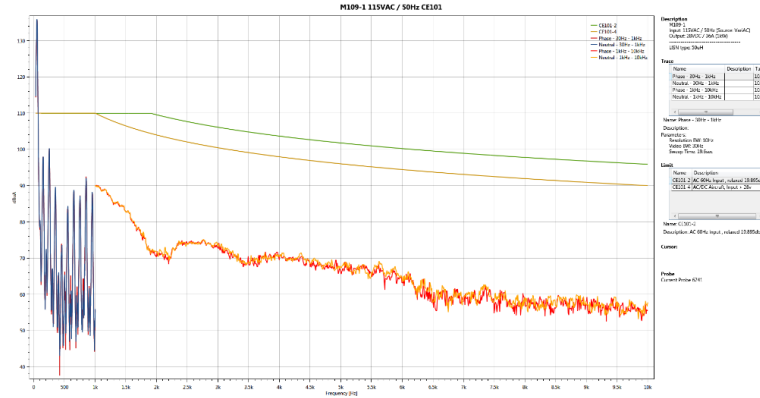

CE102 - 10 kHz to 150 kHz:

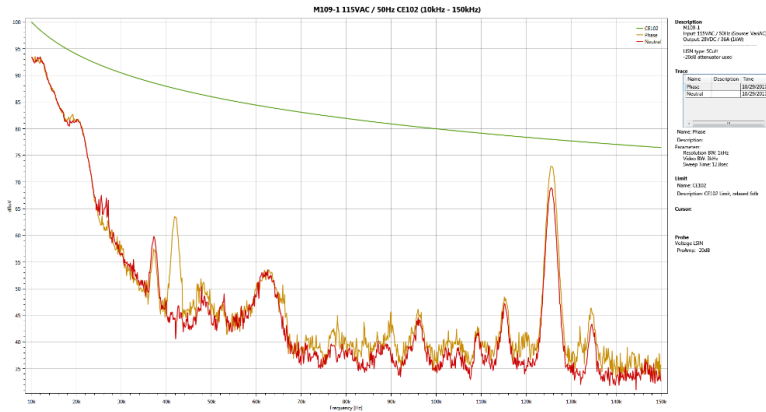

CE102 - 150 kHz to 10 MHz:

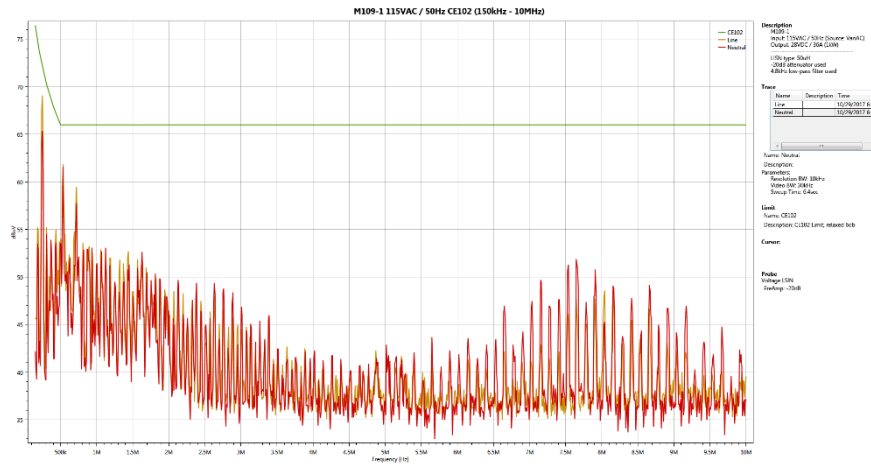

M109 Series– AC/DC Power Supply

RE102

Input: 115 VAC / 400 Hz , Output: 28 VDC / 36 A (1000 W)

2-30MHZ(ONLY VERTICAL):

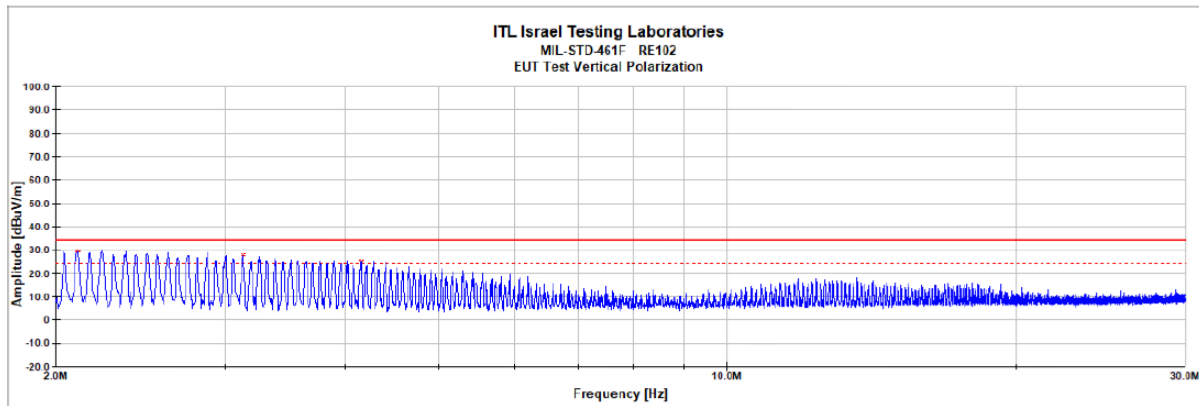

30-200MHZ

Vertical:

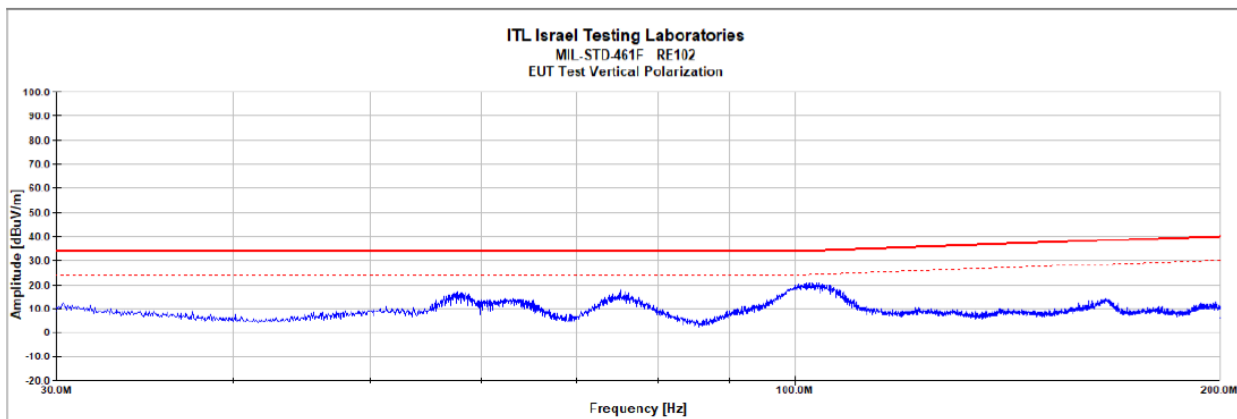

M109 Series– AC/DC Power Supply

Horizontal:

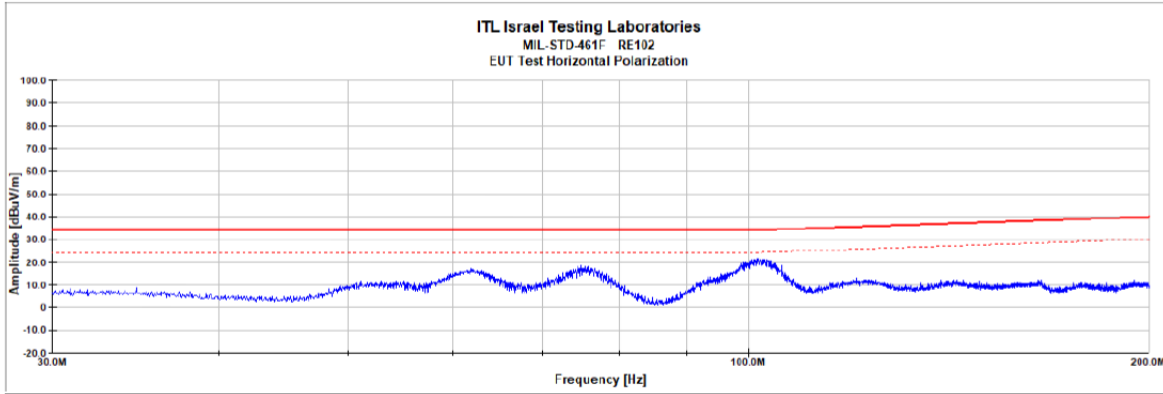

200-1000MHZ

Vertical:

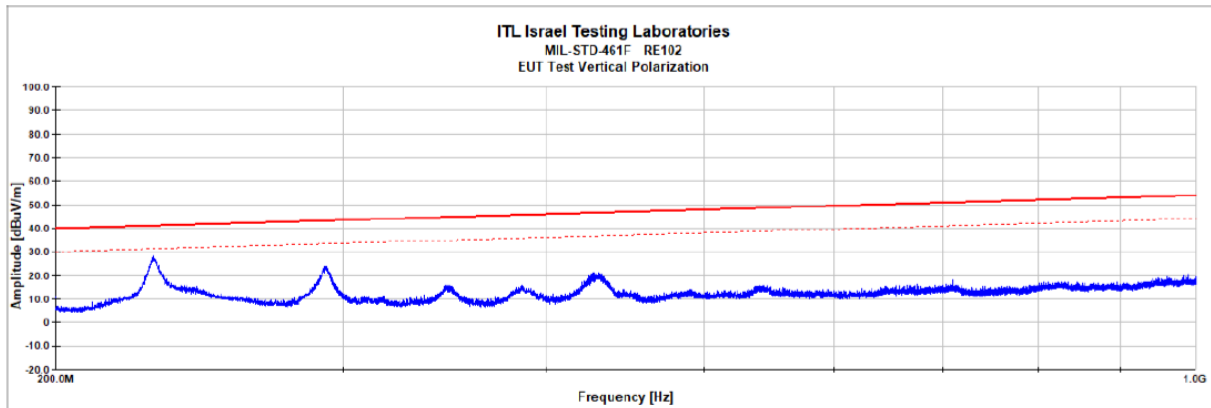

M109 Series– AC/DC Power Supply

Horizontal:

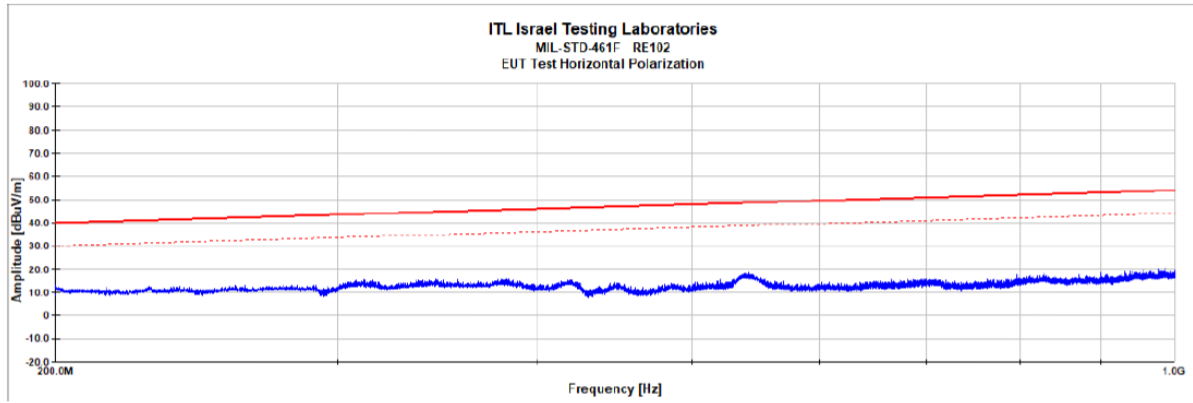

1-18GHZ

Vertical:

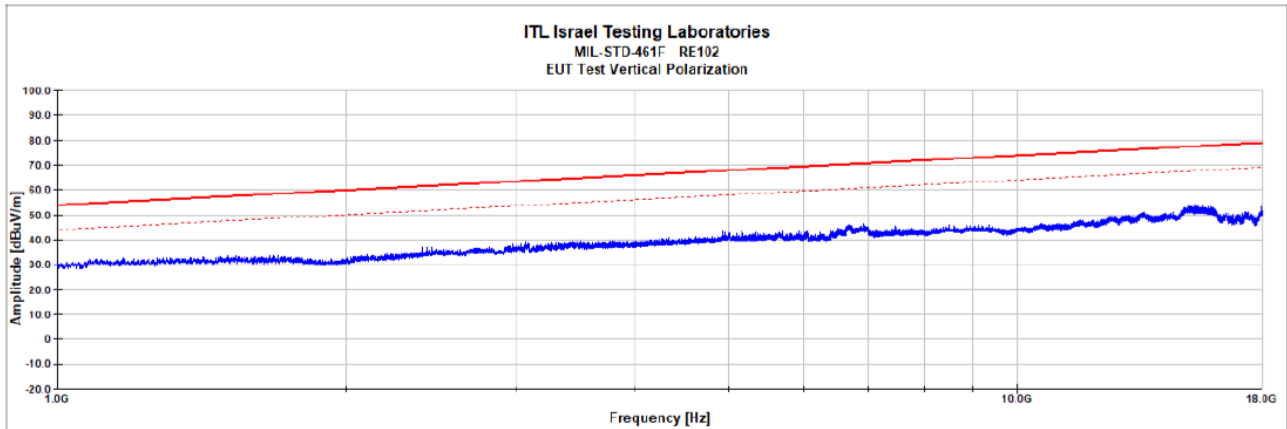

M109 Series– AC/DC Power Supply

Horizontal:

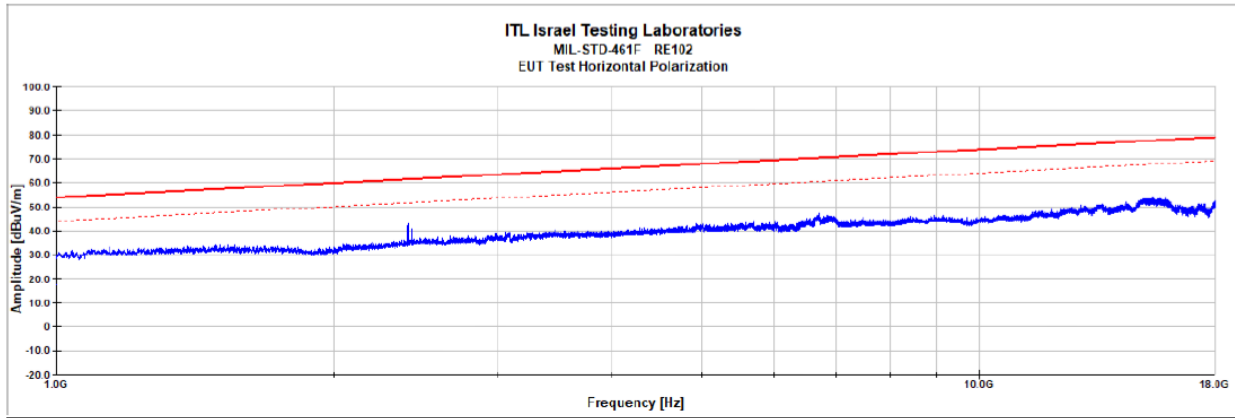

Vertical results

Frequency (Hz)	Measurement (dBuV)	Cable Loss (dB)	AF (1/m)	LNA Gain (dB)	Result (dBuV/m)	Limit (dBuV/m)	Margin (dB)
2.110 MHz	30.110	0.003	5.512	13.791	29.808	24.000	-5.808
3.130 MHz	28.064	0.004	5.772	20.226	28.182	24.000	-4.182
4.155 MHz	24.883	0.005	6.009	10.496	25.408	24.000	-1.408

M109 Series– AC/DC Power Supply

CE102

Input: 115 VAC / 400 Hz , Output: 28 VDC / 36 A (1000 W)

NETUTRAL:

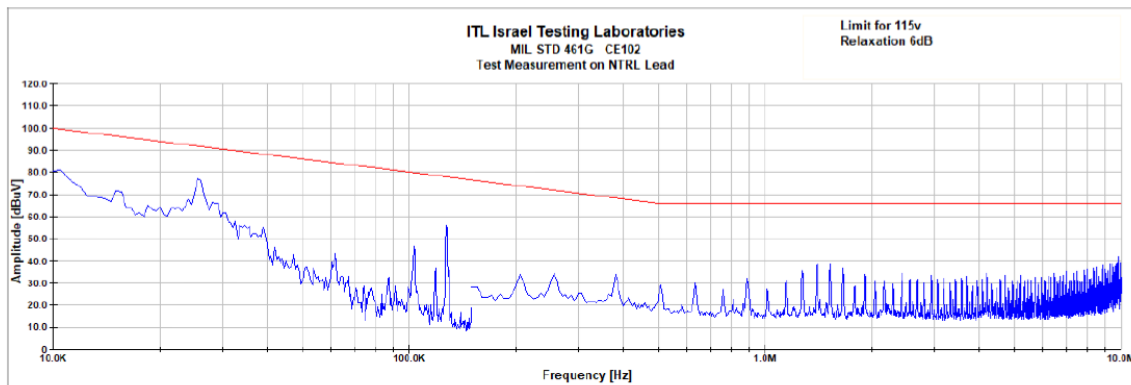

PHASE:

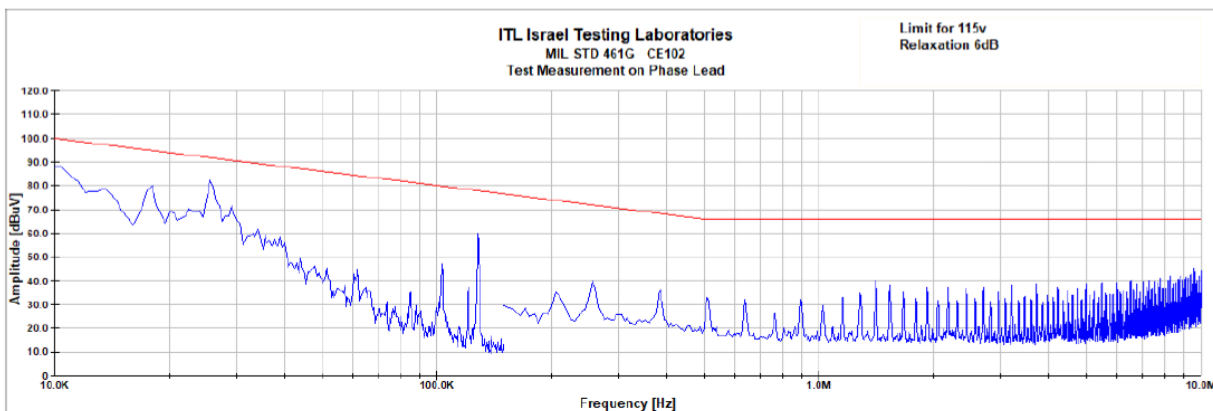

M109 Series– AC/DC Power Supply

PIN ASSIGNMENT: J1 - INPUT CONNECTOR

Connector type: Positronic DD26M4000C-50 or eq. (e.g. M24308/24-74F)

Mates with: Positronic DD26S1000C-50 or eq. (e.g. M24308/2-12F).

Pin No.	Function	P	Pin No.	Function	P	Pin No.	Function	P
1	CHASSIS		10	CHASSIS		19	N/C	
2	N/C		11	N/C		20	NEUTRAL	0
3	NEUTRAL	0	12	NEUTRAL	0	21	NEUTRAL	0
4	NEUTRAL	0	13	NEUTRAL	0	22	NEUTRAL	0
5	NEUTRAL	0	14	NEUTRAL	0	23	N/C	
6	N/C		15	N/C		24	PHASE	~
7	PHASE	~	16	PHASE	~	25	PHASE	~
8	PHASE	~	17	PHASE	~	26	PHASE	~
9	PHASE	~	18	PHASE	~			

Note: All pins with identical function/designation should be connected together for optimal performance.

CHASSIS Note: Chassis PIN (connector J1, pins 1 and 10)

The CHASSIS pin allows additional connection of unit's chassis to system ground.

M109 Series– AC/DC Power Supply

PIN ASSIGNMENT: J2 - OUTPUT CONNECTOR

Connector type: Positronic DD62SM4000C-50 or eq. (e.g. M24308/23-76F)

Mates with: Mates with: Positronic DD62M1000C-50 or eq. (e.g. M24308/4-14F)

Pin No.	Function	P	Pin No.	Function	P	Pin No.	Function	P
1	OUT	+	22	OUT	+	43	OUT	+
2	OUT	+	23	OUT	+	44	OUT	+
3	OUT	+	24	OUT	+	45	OUT	+
4	OUT	+	25	OUT	+	46	OUT	+
5	OUT	+	26	OUT	+	47	OUT	+
6	OUT	+	27	OUT	+	48	OUT	+
7	OUT	+	28	OUT	+	49	OUT	+
8	OUT	+	29	OUT	+	50	OUT	+
9	OUT RTN	-	30	OUT	+	51	OUT	+
10	OUT RTN	-	31	OUT RTN	-	52	OUT RTN	-
11	OUT RTN	-	32	OUT RTN	-	53	OUT RTN	-
12	OUT RTN	-	33	OUT RTN	-	54	OUT RTN	-
13	OUT RTN	-	34	OUT RTN	-	55	OUT RTN	-
14	OUT RTN	-	35	OUT RTN	-	56	OUT RTN	-
15	OUT RTN	-	36	OUT RTN	-	57	OUT RTN	-
16	OUT RTN	-	37	OUT RTN	-	58	OUT RTN	-
17	OUT RTN	-	38	OUT RTN	-	59	OUT RTN	-
18	SENSE RTN	-	39	OUT RTN	-	60	N/C	
19	SENSE	+	40	N/C		61	N/C	
20	INHIBIT	+	41	N/C		62	SYNC IN	+
21	SIGNAL RTN	-	42	SYNC OUT	+			

Note: All pins with identical function/designation should be connected together for optimal performance.

CHASSIS Note: Chassis PIN (connector J1, pins 1 and 10)

The CHASSIS pin allows additional connection of unit's chassis to system ground.

M109 Series– AC/DC Power Supply

OUTLINE DRAWING:

For detailed dimensions and tolerances see Drawing: M109001

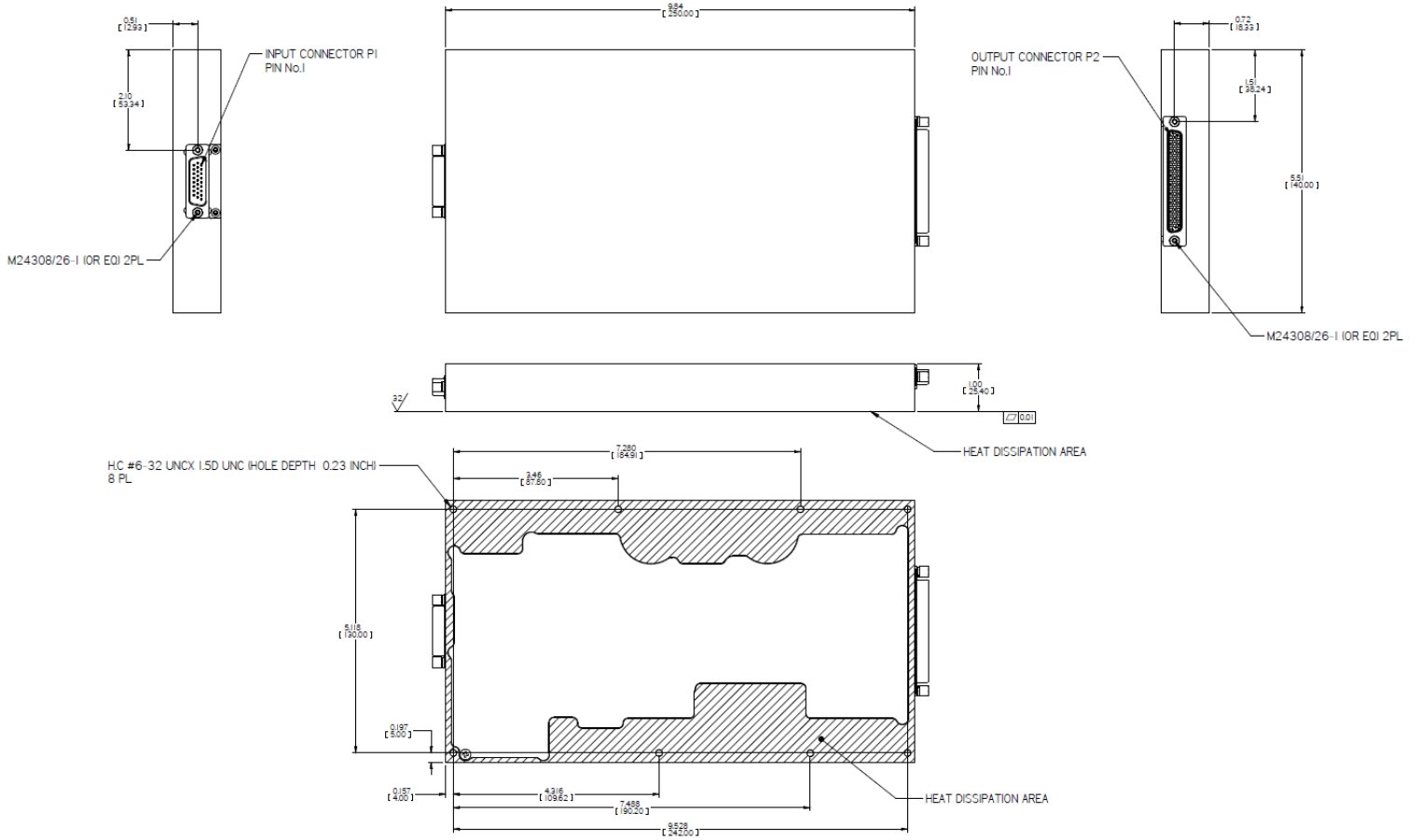

Note: Specifications are subject to change without prior notice by the manufacturer.