



## MILTECH™ 9117 TSN

8 x 1GBaseT + 4 x 1G/10GBaseT + 4 x 1/10G F/O Ethernet L2/L3 switch with Full TSN and Input/Output clocks With Cisco® IOS® - XE 8000V using powerful SBC

MILTECH 9117 TSN is a member of the super-speed ethernet switches, aimed at providing advanced timing solutions for military applications on top of a standard Ethernet switch.

Providing 8 x 10/100/1000Base-T ports, 4 x 100M/1G/10GBase-T, 4 x 1/10G F/O, 1PPS, and 10MHz (In and Out), this switch is designed to support networking and precise timing applications such as manned/autonomous vehicles, Avionics, UAVs, and mobile equipment in battlefield environments supporting super-speed networking and time precision.

MILTECH 9117TSN supports advanced Time-Sensitive Networking (TSN) features, including Time-Aware Shaper (TAS), Frame Preemption, and Per-Stream Filtering and Policing (PSFP). These capabilities ensure deterministic data delivery and low-latency communication, which is essential for real-time military applications.

The integrated Cisco 8000V router transparently connects to a mobile world of wired and wireless networks, with IPv4/IPv6 routing and multicast protocols that include BGP, OSPF, GRE, EIGRP, CDP, IGMP and MLD. Voice and video connection quality is maintained with advanced quality of service (QoS) while external communications is secured with the latest encryption algorithms, IPsec and IKEv2 protocols, authentication, identity management, and integrated threat management. These advanced functions normally require a separate edge router but are now available in our compact MILTECH 9117 TSN.

The switch's hardware-based timestamping and synchronization mechanisms, compliant with IEEE 802.1AS and IEEE 802.1Qbv standards, enable precise time coordination across networked devices. The MILTECH 9117 TSN's support for multiple timing domains and seamless integration with existing network infrastructure make it a versatile solution for complex, mission-critical environments.

MILTECH 9117 TSN design to meet the IP67, MIL-STD-810: thermal, shock, vibration, altitude, humidity and MIL-STD-461 EMI/EMC.

Wide range of DC input (18-48VDC) and MIL-STD-1275/704 power supply allows easy integration in existing and new solutions.

The durable design, flat mounting surface, and RoHS / REACH Compliance make the MILTECH 9117 TSN suitable for almost any application.



**NIST**  
800-171  
Compliant





## SPECIFICATIONS

<p>ETHERNET PORTS:</p>	<ul style="list-style-type: none"> <li>• 8 x 10/100/1000Base-T ports (one is connected to internal SBC)</li> <li>• 4 x 100M/1G/10GBase-T ports</li> <li>• 4 x 1/10G F/O ports</li> </ul>
<p>CLOCK PORTS:</p>	<ul style="list-style-type: none"> <li>• 1x 1PPS (In and Out): RS422/TTL, 3.3v/5v</li> <li>• 1x 10MHz (In and Out): Sine/Square (different PN) , 3.3v/5v</li> </ul> <p>Input clocks are programmable, and can be changed on the fly using CLI command</p>
<p>SBC (COM-E Type 10):</p>	<ul style="list-style-type: none"> <li>• CPU: Intel Atom® x6413E (4C/4T, 1.50 GHz, 9W)</li> <li>• Memory: 8GB LPDDR4</li> <li>• Onboard Storage: eMMC 64Gb</li> <li>• OS: Red Hat Enterprise Linux</li> <li>• Cisco Soft Router: Cisco Catalyst 8000V – (Optional)</li> </ul>
<p>TSN / TIMING: Capabilities:</p>	<ul style="list-style-type: none"> <li>• SyncE with SSM support</li> <li>• SyncE combined with 1588</li> <li>• PTP Profiles</li> <li>• 1588v2 PTP with one / two step clock</li> <li>• NTPv4 Client</li> <li>• Boundary Clock</li> <li>• DPLL configuration for different clocks inputs /outputs</li> <li>• TC internal Master/Slave w. PDV filtering</li> <li>• Redundant masters and multiple timing domains</li> <li>• Peer-to-peer transparent clock over Ethernet/IPv4</li> <li>• End-to-end transparent clock over Ethernet/IPv4 and IPv6</li> <li>• Unicast/Multicast</li> <li>• IEEE-802.1Qbv (TAS) Time-aware Scheduler</li> <li>• IEEE-802.1Qbu &amp; 802.3br Frame Preemption</li> <li>• IEEE-802.1Qci ingress gating/policing/checking</li> <li>• IEEE-802.1CB (FRER)</li> <li>• IEEE802.1AS-2011/IEEE802.1AS rev D4.2</li> <li>• G.781 compliant clock selection algorithm for the platform as a PTP slave</li> </ul>
<p>NETWORKING: L2/L3 capabilities</p>	<ul style="list-style-type: none"> <li>• Software-based IPv4/6 L3 static routing</li> <li>• MAC: Static / Auto learning</li> <li>• VLAN (MAC based, IP based, Protocol based, Subnet based)</li> <li>• Bidirectional / unidirectional VLAN translation</li> <li>• iPVLAN / VLAN trunking</li> <li>• Multiple VLAN Registration Protocol</li> <li>• Spanning Tree Protocol / Rapid Spanning Tree Protocol / Multiple Spanning Tree Protocol</li> <li>• Loop guard and loop free operation</li> <li>• Media redundancy protocol / interconnect</li> <li>• Ring protection V1/V2</li> <li>• Link aggregation</li> <li>• sFlow</li> </ul>
<p>NETWORKING: Security</p>	<ul style="list-style-type: none"> <li>• MACSec Support using PCH/MCH Headers</li> <li>• ACLs for filtering/policing</li> <li>• Port isolation, control and security and port based 802.1X</li> <li>• Spoofing and inspection: DHCP, IGMPv2/v3, MLDv1/v3, ARP</li> <li>• Port mirroring / Remote mirroring / Flow mirroring</li> <li>• IEEE 802.1Qbb (Flow control)</li> <li>• DHCPv6 Shield</li> <li>• VLAN assignment</li> <li>• QoS assignment (auto, manual)</li> <li>• MAC address limit and authentication</li> <li>• IP/MAC binding (dynamic, static)</li> <li>• IP source guard</li> <li>• RADIUS authentication, authorization and accounting</li> <li>• TACACS+ authentication, authorization, accounting</li> </ul>

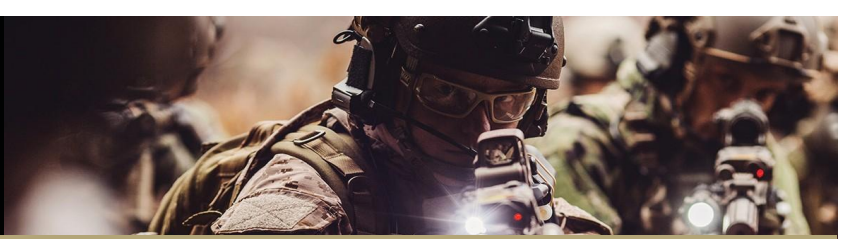

## SPECIFICATIONS

<p><b>NETWORKING:</b> Additional capabilities</p>	<ul style="list-style-type: none"> <li>• Ingress policing</li> <li>• Rate limit</li> <li>• Egress queuing/shaping</li> <li>• Jumbo frame size support</li> </ul>
<p><b>NETWORKING:</b> Management</p>	<ul style="list-style-type: none"> <li>• Management interfaces: Web UI, CLI, Telnet, HTTPS, SSH</li> <li>• Monitoring: SNMP, RMON</li> <li>• Services: DHCP client and server, DNS client, FTP/Secure FTP Client</li> <li>• Operation: Management access filtering, System syslog, IPv4/IPv6 ping and traceroute</li> <li>• Remote update</li> <li>• Secured boot</li> </ul>
<p><b>CISCO NETWORKING:</b> General</p>	<ul style="list-style-type: none"> <li>• Routing Information Protocol (RIP) Versions 1 and Open Shortest Path First (OSPF)</li> <li>• Enhanced Interior Gateway Routing Protocol (EIG) Border Gateway Protocol (BGP)</li> <li>• Cisco Discovery Protocol IP Policy Routing</li> <li>• IP Multicast Protocol Independent Multicast (PIM) Versions 1 and 2 Internet Group Management Protocol (IGMP) Versions 1, 2, and 3 IP Multicast Load Splitting</li> <li>• Cisco Group Management Protocol (GMP) Up to 32 VLANs supported per router</li> <li>• IPv4 support:             <ul style="list-style-type: none"> <li>- IPv6 routing and Cisco Express Forwarding switching</li> <li>  IPv6 QoS</li> <li>  IPv6 tunneling support</li> </ul> </li> <li>• Cisco IOS Zone-Based Firewall for IPv6 traffic</li> <li>- Encapsulations             <ul style="list-style-type: none"> <li>  Point-to-Point Protocol (PPP)</li> <li>  PPP over Ethernet (PPPoE) client and server for Fast Ethernet</li> <li>  802.1q VLAN trunking support</li> <li>  Generic routing encapsulation (GRE)</li> </ul> </li> </ul>
<p><b>CISCO NETWORKING:</b> General</p>	<ul style="list-style-type: none"> <li>• Radio-Aware Routing             <ul style="list-style-type: none"> <li>- Optimizes IP routing over fixed or temporary radio networks</li> <li>- Factors radio link metrics into route calculations</li> <li>- Immediately recognizes and adapts to changes in network neighbor status</li> <li>- Supports Dynamic Link Exchange Protocol (DLEP)</li> <li>- Supports Router Radio Control Protocol (R2CP)</li> <li>- Supports RFC 5578 (authored by Cisco)</li> </ul> </li> <li>• Mobile Ad-Hoc Networks             <ul style="list-style-type: none"> <li>- OSPFv3 enhancements for mobile ad-hoc networks</li> </ul> </li> </ul>
<p><b>CISCO NETWORKING:</b> Quality of Service</p>	<ul style="list-style-type: none"> <li>• QoS</li> <li>• Generic traffic shaping</li> <li>• Class-based Ethernet matching and mobile access routing (802.1p class of service [CoS])</li> <li>• Committed access rate</li> <li>• Flow-based Weighted Random Early Detection (WRED)</li> <li>• Class-Based Weighted Fair Queuing (CBWFQ)</li> <li>• Low Latency Queuing (LLQ)</li> <li>• Priority Queuing</li> <li>• Weighted Fair Queuing (WFQ)</li> <li>• Traffic Policing Resource Reservation Protocol (RSVP)</li> </ul>

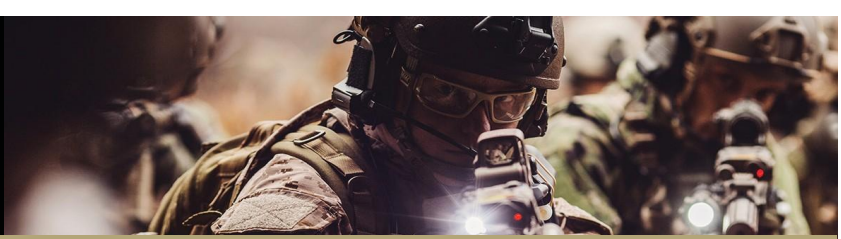

## SPECIFICATIONS

CHASSIS:	<ul style="list-style-type: none"> <li>• Low profile rugged machined aluminum</li> <li>• Conductively cooled</li> <li>• Ingress protection against sand, dust and moisture</li> <li>• Material: AL6061-T651 per AMS QQ-250/11</li> <li>• Anodize Coating, MIL-A-8625, Type II, Class 2, Black color</li> </ul>
STANDARDS:	<ul style="list-style-type: none"> <li>• Designed to meet MIL-STD-461, MIL-STD-810, MIL-STD-1275, MIL-STD-704, IP67</li> <li>• RoHS and REACH Compliance</li> <li>• NGVA Aligned (Nato Generic Vehicle Architecture)</li> </ul>
LED INDICATION	<ul style="list-style-type: none"> <li>• Power</li> <li>• Status (Built-In Self-Test)</li> <li>• Per port indications: Link/Activity</li> <li>• 1PPS In and Out</li> <li>• 10MHz In and Out</li> </ul> <p>Dark mode enable/disable by software</p>
POWER:	<ul style="list-style-type: none"> <li>• Power Input: 28VDC Nominal (18-48V)</li> <li>• Power Consumption: 82W Max</li> <li>• Chassis grounding</li> <li>• MILSTD-1275, MILSTD-704</li> </ul>
ELECTROMAGNETIC:	<ul style="list-style-type: none"> <li>• MIL-STD-461F Electromagnetic compatibility CE-101, CE-102, CS-101, CS-114, CS-115, CS-116, RE-101, RS-102, RS101, RS103</li> </ul>
ENVIRONMENTAL:	<ul style="list-style-type: none"> <li>• IP67</li> <li>• MILSTD-810: Random vibration, Bench Handling, Air Pressure, Blowing Rain, Immersion, High/Low Temp, Humidity, Salt Atmosphere, Blowing Dust, Loose Cargo Vibration</li> </ul>
PHYSICAL:	<ul style="list-style-type: none"> <li>• Dimensions: 344.0mm(L) x 204.0mm(W) x 79mm(H), excluding connectors</li> <li>• Dimensions: 13.54"(L) x 8.03" (W) x 3.11"(H), excluding connectors</li> <li>• Weight: 4Kg (8.82 lbs.)</li> </ul>
COOLING:	<ul style="list-style-type: none"> <li>• No Moving Parts. Passive Cooling.</li> </ul>
TEMPERATURE:	<ul style="list-style-type: none"> <li>• Operational: -40°C to +71°C (-40°F to +160°F)</li> <li>• Storage: -55°C to +80°C (-67°F to +176°F)</li> </ul>
CONNECTORS:	<ul style="list-style-type: none"> <li>• J1 Power: D38999/24WC04PN</li> <li>• J2,3 F/O : EB4H8000-3445</li> <li>• J4 10G ETH: 10-646402-643N</li> <li>• J5 ETH: D38999-24WF35PN</li> <li>• J6 Clocks: TV07DZ13-26S(S25)</li> </ul> <p>Chassis ground: #8-32 UNC stainless steel screw</p>

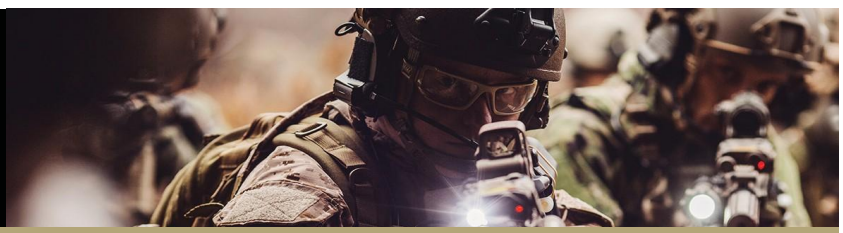

**A**

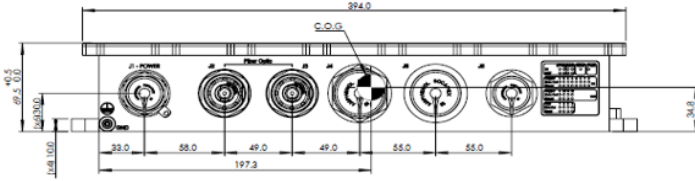

**B**

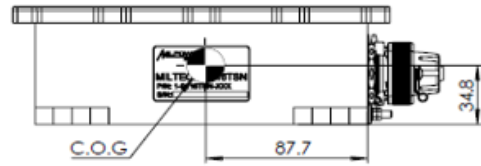

**C**

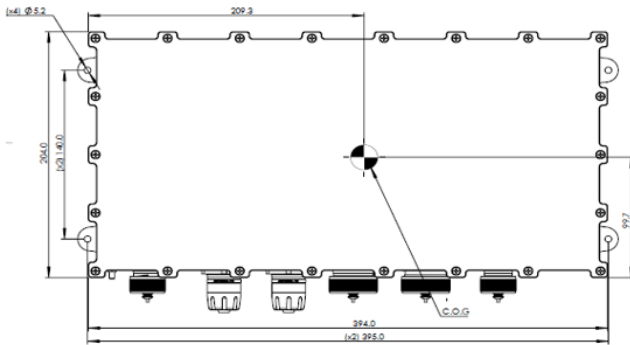

**D**

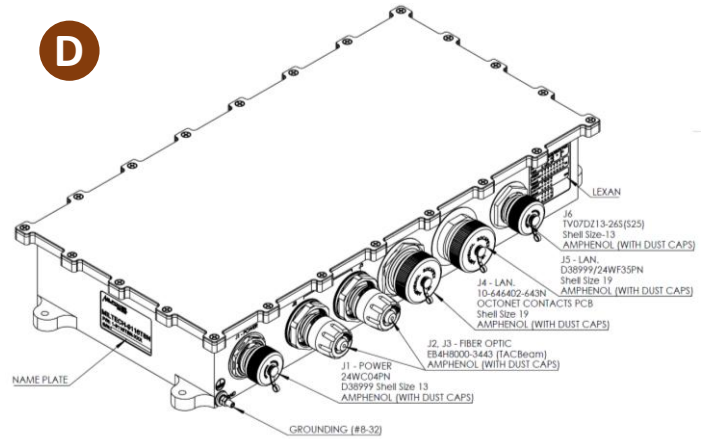

## ORDERING INFORMATION

PART NUMBER	DESCRIPTION
1-9117TSN-010	16 Port, 1G/10G Military Grade Ethernet Switch with TSN , RHEL
1-9117TSN-011	16 Port, 1G/10G Military Grade Ethernet Switch with TSN + 25Mbps Cisco Router License
1-9117TSN-012	16 Port, 1G/10G Military Grade Ethernet Switch with TSN + 200Mbps Cisco Router License
1-9117TSN-013	16 Port, 1G/10G Military Grade Ethernet Switch with TSN + 1Gbps Cisco Router License
2-CBL9117TSNKIT	MILTECH 9117TSN Cable Set