



MILTECH™ 9116 TSN

8 x 1GBase-T + 4 x 100M/1G/10GBase-T + 4 x 1/10G F/O Ethernet L2/L3 switch with Full TSN and Input/Output clocks

MILTECH 9116 TSN is a member of the super-speed TSN Ethernet switches, aimed at providing advanced timing solutions for military applications on top of a standard Ethernet switch (such as MILTECH9116).

Providing 8x 10/100/1000Base-T ports, 4 x 100M/1G/10GBase-T, 4 x 1/10G F/O, 1PPS, and 10MHz (In and Out), this switch is designed to support networking and precise timing applications such as manned/autonomous vehicles, Avionics, UAVs, and mobile equipment in battlefield environments supporting super-speed networking and time precision.

MILTECH 9116TSN supports advanced Time-Sensitive Networking (TSN) features, including Time-Aware Shaper (TAS), Frame Preemption, and Per-Stream Filtering and Policing (PSFP). These capabilities ensure deterministic data delivery and low-latency communication, which is essential for real-time military applications.

Along with most common routing protocols such as RIP, OSPF and IPv6 Static routing, the switch's hardware-based timestamping and synchronization mechanisms, compliant with IEEE 802.1AS and IEEE 802.1Qbv standards, enable precise time coordination across networked devices. The MILTECH 9116TSN's support for multiple timing domains and seamless integration with existing network infrastructure make it a versatile solution for complex, mission-critical environments.

Equipped with MIL circular connectors that meet the NGVA standards and a durable enclosure, the MILTECH 9116TSN is designed to withstand harsh conditions with ease.

MILTECH9116TSN is designed to meet the IP67, MIL-STD-810: thermal, shock, vibration, altitude, humidity, along with MIL-STD-461 EMI/EMC

Wide range of DC input (18-48VDC) and MIL-STD-1275/704 power supply allows easy integration in existing and new solutions

The durable design, flat mounting surface, and RoHS / REACH Compliance make the MILTECH9116TSN suitable for almost any application



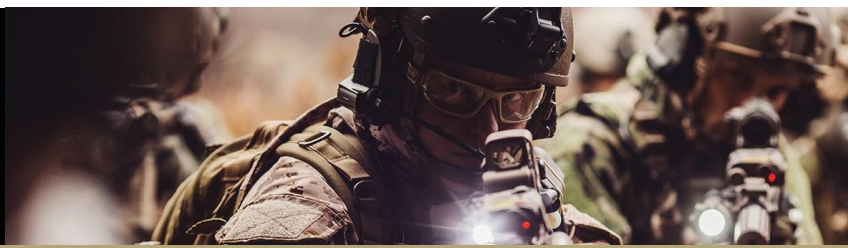

SPECIFICATIONS

ETHERNET PORTS:	<ul style="list-style-type: none"> • 8 x 10/100/1000Base-T ports • 4 x 100M/1G/10GBase-T ports • 4 x 1/10G F/O ports
CLOCK PORTS:	<ul style="list-style-type: none"> • 1x 1PPS (In and Out): RS422/TTL, 3.3v/5v • 1x 10MHz (In and Out): Sine/Square (different PN) , 3.3v/5v <p>Input clocks are programmable, and can be changed on the fly using CLI command</p>
TSN / TIMING: Capabilities:	<ul style="list-style-type: none"> • SyncE with SSM support • SyncE combined with 1588 • PTP Profiles • 1588v2 PTP with one / two step clock • NTPv4 Client • Boundary Clock • DPLL configuration for different clocks inputs /outputs • TC internal Master/Slave w. PDV filtering • Redundant masters and multiple timing domains • Peer-to-peer transparent clock over Ethernet/IPv4 • End-to-end transparent clock over Ethernet/IPv4 and IPv6 • Unicast/Multicast • IEEE-802.1Qbv (TAS) Time-aware Scheduler • IEEE-802.1Qbu & 802.3br Frame Preemption • IEEE-802.1Qci ingress gating/policing/checking • IEEE-802.1CB (FRER) • IEEE802.1AS-2011/IEEE802.1AS rev D4.2 <p>G.781 compliant clock selection algorithm for the platform as a PTP slave</p>
NETWORKING: L2/L3 capabilities	<ul style="list-style-type: none"> • Software-based IPv4 dynamic routing and IPv6 static routing <ul style="list-style-type: none"> • RIPv2 • OSPFv2, OSPFv3 • MAC: Static / Auto learning • VLAN (MAC based, IP based, Protocol based, Subnet based) • Bidirectional / unidirectional VLAN translation • iPVLAN / VLAN trunking • Multiple VLAN Registration Protocol • Spanning Tree Protocol / Rapid Spanning Tree Protocol / Multiple Spanning Tree Protocol • Loop guard and loop-free operation • Media redundancy protocol / interconnect • Ring protection V1/V2 • Link aggregation • sFlow
NETWORKING: Security	<ul style="list-style-type: none"> • MACSec Support using PCH/MCH Headers • ACLs for filtering/policing • Port isolation, control and security and port based 802.1X • Spoofing and inspection: DHCP, IGMPv2/v3, MLDv1/v3, ARP • Port mirroring / Remote mirroring / Flow mirroring • IEEE 802.1Qbb (Flow control) • DHCPv6 Shield • VLAN assignment • QoS assignment (auto, manual) • MAC address limit and authentication • IP/MAC binding (dynamic, static) • IP source guard • RADIUS authentication, authorization and accounting • TACACS+ authentication, authorization, accounting

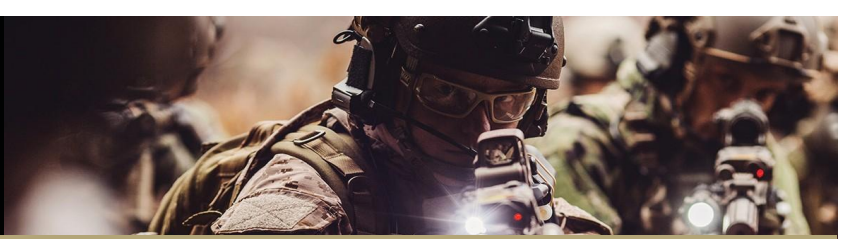

SPECIFICATIONS

NETWORKING: Additional capabilities	<ul style="list-style-type: none"> Ingress policing Rate limit Egress queuing/shaping Jumbo frame size support
NETWORKING: Management	<ul style="list-style-type: none"> Management interfaces: Web UI, CLI, Telnet, HTTPS, SSH Monitoring: SNMP, RMON Services: DHCP client and server, DNS client, FTP/Secure FTP Client Operation: Management access filtering, System syslog, IPv4/IPv6 ping and traceroute Remote update Secured boot
CHASSIS:	<ul style="list-style-type: none"> Low profile rugged machined aluminum Conductively cooled Ingress protection against sand, dust and moisture Material: AL6061-T651 per AMS QQ-250/11 Anodize Coating, MIL-A-8625, Type II, Class 2, Black color
STANDARDS:	<ul style="list-style-type: none"> Designed to meet MIL-STD-461, MIL-STD-810, MIL-STD-1275, MIL-STD-704, IP67 RoHS and REACH Compliance NGVA Aligned (Nato Generic Vehicle Architecture)
LED INDICATION	<ul style="list-style-type: none"> Power Status (Built-In Self-Test) Per port indications: Link/Activity 1PPS In and Out 10MHz In and Out Dark mode enable/disable by software
POWER:	<ul style="list-style-type: none"> Power Input: 28VDC Nominal (16-50V) Power Consumption: 62W Max Chassis grounding MILSTD-1275, MILSTD-704
ELECTROMAGNETIC:	<ul style="list-style-type: none"> MIL-STD-461F Electromagnetic compatibility CE-101, CE-102, CS-101, CS-114, CS-115, CS-116, RE-101, RS-102, RS101, RS103
ENVIRONMENTAL:	<ul style="list-style-type: none"> IP67 MILSTD-810: Random vibration, Bench Handling, Air Pressure, Blowing Rain, Immersion, High/Low Temp, Humidity, Salt Atmosphere, Blowing Dust, Loose Cargo Vibration
PHYSICAL:	<ul style="list-style-type: none"> Dimensions: 344.0mm(L) x 204.0mm(W) x 79mm(H), excluding connectors Dimensions: 13.54"(L) x 8.03" (W) x 3.11"(H), excluding connectors Weight: 4KG (8.82 lbs.)
COOLING:	<ul style="list-style-type: none"> No Moving Parts. Passive Cooling.
TEMPERATURE:	<ul style="list-style-type: none"> Operational: -40°C to +71°C (-40°F to +160°F) Storage: -55°C to +80°C (-67°F to +176°F)
CONNECTORS:	<ul style="list-style-type: none"> J1 Power: D38999/24ZC04PN J2,3 F/O : EB4H8000-3443 (S/M), EB4H8000-3413 (M/M) J4 10G ETH: 10-646406-055N J5 1G ETH: D38999/24ZF35PN J6 Clocks: 10-646401-663N Chassis ground: #8-32 UNC stainless steel screw

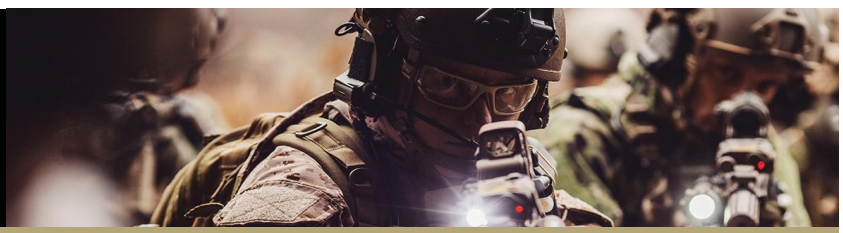

A

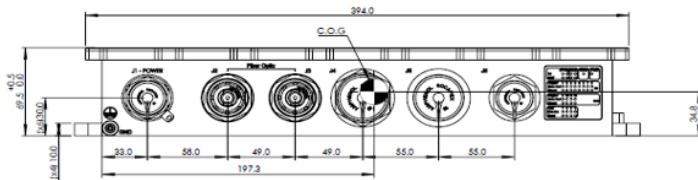

B

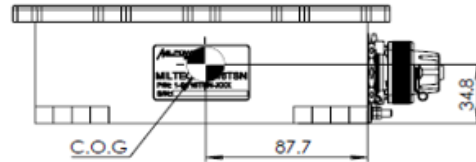

C

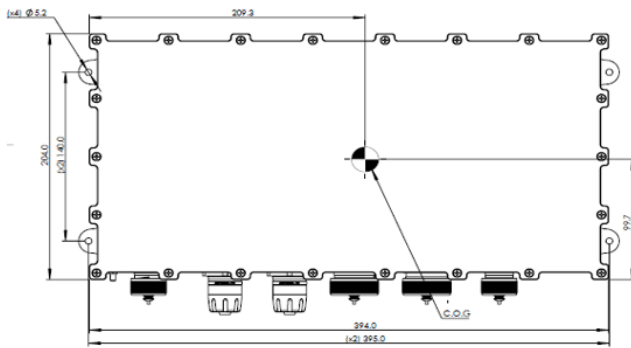

D

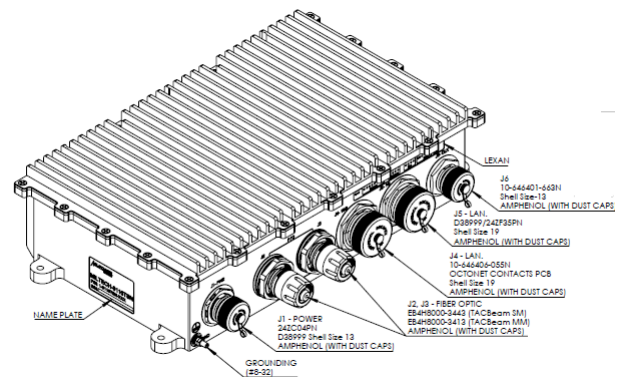

ORDERING INFORMATION

PART NUMBER	DESCRIPTION
1-9116TSN-010	16 Port, 1G/10G switch with TSN (IEEE 802.1Q) and Input/Output clocks, Square 10MHZ waveform, 10G Single-Mode Fiber
1-9116TSN-110	16 Port, 1G/10G switch with TSN (IEEE 802.1Q) and Input/Output clocks, Square 10MHZ waveform, 10G Multi-Mode Fiber
2-CBL9116TSNKIT	MILTECH 9116TSN Cable Set with Multi-Mode Fibers
2-CBL9116TSNKIT2	MILTECH 9116TSN Cable Set with Single-Mode Fibers